

# TX-28LD7C Service Manual

Safety

Specifications

Parts List

Service  
Information

Adjustments

Self Check

Service Hints

Mechanical  
View

Disassembly

Location of  
Controls

Waveforms

Block Diagrams

Schematic Diagrams

PCB Views

## Service Support

Service and repair of this product is supported by Panasonic's LUCI interface.

This interface provides a link between the TV and a standard PC to allow a number of diagnostic and control functions to be performed.

For more details contact your local Panasonic company.

  
BACK

EXIT

Video / Audio

Control

  
BACK

B - PCB

E - PCB

Y - PCB

B - Schematic

E - Schematic

P - Schematic

Y - Schematic

  
BACK

  
BACK

# Service Manual



## Colour Television

## TX-28LD7C

## EURO-2L Chassis

### Specifications

<b>Power Source :</b>	220 - 240 V AC, 50Hz
<b>Power Consumption :</b>	97W
<b>Aerial Impedance :</b>	75Ω unbalanced, Coaxial Type
<b>Receiving System :</b>	PAL B/G, D/K H, PAL - 60 SECAM B/G, D/K M.NTSC, NTSC (AV Only)
<b>Receiving Channels :</b>	VHF E2 - E12 VHF H1 - H2 (ITALY) VHF A - H (ITALY) VHF R1 - R2 VHF R3 - R5 VHF R6 - R12 UHF E21 - E69 CATV (S01 - S05) CATV S11 - S20 (U1 - U10)
<b>Intermediate Frequency :</b>	Video 38.9MHz Sound 33.4MHz, 33.16MHz 32.4MHz, 33.05MHz 35.07MHz, 34.47MHz, 34.5MHz
<b>Colour</b>	
<b>Video / Audio Terminals :</b>	
AV1 IN	Video (21 pin) 1V p-p 75Ω Audio (21 pin) 500mV rms 10kΩ RGB (21 pin)
AV1 OUT	Video (21 pin) 1V p-p 75Ω Audio (21 pin) 500mV rms 1kΩ
AV2 IN	Video (21 pin) 1V p-p 75Ω Audio (21 pin) 500mV rms 10 kΩ S-Video IN Y : 1V p-p 75Ω (21 pin) C : 0.3V p-p 75Ω
AV2 OUT	Video (21 pin) 1V p-p 75Ω Audio (21 pin) 500mV rms 1kΩ
AV3 IN	Audio (RCA x 2) 500mV rms 10kΩ Video (RCA x 1) 1V p-p 75Ω
<b>High Voltage :</b>	28 kV ± 1kV at zero beam current
<b>Picture Tube :</b>	A66ECF50X12
<b>Visible screen size :</b>	66 cm
<b>Audio Output :</b>	
Internal Speaker	2 x 15 W (Music Power) 8 Ω Impedance
Headphones	8 Ω Impedance
<b>Accessories supplied :</b>	Remote Control 2 x R6 (UM3) Batteries
<b>Dimensions :</b>	Height : 582mm Width : 752mm Depth : 462mm
<b>Net Weight :</b>	32kg
Specifications are subject to change without notice. Weight and dimensions shown are approximate.	

### Technische Daten

<b>Netzspannung :</b>	220 - 240 V AC, 50Hz
<b>Leistungsaufnahme :</b>	97W
<b>Antennenimpedanz :</b>	75Ω asymmetrisch, Koaxial-Typ
<b>Empfangssystem :</b>	PAL B/G, D/K H, PAL - 60 SECAM B/G, D/K M.NTSC, NTSC (nur AV Eingang)
<b>Empfangsbereiche :</b>	VHF E2 - E2 VHF H1 - H2 (ITALY) VHF A - H (ITALY) VHF R1 - R2 VHF R3 - R5 VHF R6 - R12 UHF E21 - E69 CATV (S01 - S05) CATV S11 - S20 (U1 - U10)
<b>Zwischenfrequenz :</b>	Video 38.9MHz Sound 33.4MHz, 33.16MHz 32.4MHz, 33.05MHz 35.07MHz, 34.47MHz, 34.5MHz
<b>Colour</b>	
<b>Video / Audio Anschlüsse :</b>	
AV1 EINGANG	Video (21 pin) 1V p-p 75Ω Audio (21 pin) 500mV rms 10kΩ RGB (21 pin)
AV1 AUSGANG	Video (21 pin) 1V p-p 75Ω Audio (21 pin) 500mV rms 1kΩ
AV2 EINGANG	Video (21 pin) 1V p-p 75Ω Audio (21 pin) 500mV rms 10 kΩ S-Video IN Y : 1V p-p 75Ω (21 pin) C : 0.3V p-p 75Ω
AV2 AUSGANG	Video (21 pin) 1V p-p 75Ω Audio (21 pin) 500mV rms 1kΩ
AV3 EINGANG	Audio (RCA x 2) 500mV rms 10kΩ Video (RCA x 1) 1V p-p 75Ω
<b>Hochspannung :</b>	28 kV ± 1kV bei Nullstrahlstrom
<b>Bildrohre :</b>	A66ECF50X12
<b>Visuelle Diagonale :</b>	66 cm
<b>Ton Ausgangsleistung :</b>	2 x 15W (Musikleistung) 8 Ω Impedanz
Kopfhörer	8 Ω Impedanz
<b>Mittel, Zubehör :</b>	Fernbedienung 2 x R6 (UM3) Batterien
<b>Abmessungen :</b>	Höhe : 582mm Breite : 752mm Tiefe : 462mm
<b>Gewicht :</b>	32kg
Änderungen der technischen Daten vorbehalten. Gewichte und Abmessungen sind Näherungsangaben.	

## CONTENTS

SAFETY PRECAUTIONS .....
SERVICE HINTS .....
LOCATION OF CONTROLS .....
ADJUSTMENTS .....
SELF CHECK .....
BLOCK DIAGRAM .....
WAVEFORM PATTERN TABLE .....
PARTS LOCATION .....
REPLACEMENT PARTS LIST .....
SCHEMATIC DIAGRAMS .....
CONDUCTOR VIEWS .....

## SAFETY PRECAUTIONS

### GENERAL GUIDE LINES

1. It is advisable to insert an isolation transformer in the AC1 supply before servicing a hot chassis.
2. When servicing, observe the original lead dress in the high voltage circuits. If a short circuit is found, replace all parts which have been overheated or damaged by the short 2. circuit.
3. After servicing, see that all the protective devices such as insulation barriers, insulation papers, shields and isolation R—C combinations are correctly installed.
4. When the receiver is not being used for a long period of time, unplug the power cord from the AC outlet.
5. Potentials as high as 29kV are present when this receiver is in operation. Operation of the receiver without the rear cover involves the danger of a shock hazard from the receiver power supply. Servicing should not be attempted 4. by anyone who is not familiar with the precautions necessary when working on high voltage equipment. Always discharge the anode of the picture to the chassis 5. before handling the tube.
6. After servicing make the following leakage current checks to prevent the customer from being exposed to shock hazards.

### LEAKAGE CURRENT COLD CHECK

1. Unplug the AC cord and connect a jumper between the two prongs of the plug.
2. Turn on the receiver's power switch.
3. Measure the resistance value with an ohmmeter, between 2. the jumpered AC plug and each exposed metallic cabinet 3. part on the receiver, such as screw heads, aerials, connectors, control shafts etc. When the exposed metallic part has a return path to the chassis the reading should be between 4M ohm and 20M ohm. When the exposed metal does not have a return path to the chassis the reading must be infinite.

## INHALT

SICHERHEITSVORKEHRUNGEN .....
WARTUNGSHINWEISE .....
LAGE DER EINSTELLREGLER .....
JUSTIERUNGEN .....
SELBSTDIAGNOSE .....
SCHALTBILD BLOCK .....
SIGNAL TABELLE .....
EXPLOSIONSZEICHNUNG .....
ERSATZTEILLISTE .....
SCHALTBILD SCHEMA .....
ANSICHT DER LEITERBAHNEN .....

## SICHERHEITSVORKEHRUNGEN

### ALLGEMEINE RICHTLINIEN

- Es ist empfehlenswert einen Trenntransformator in die Stromversorgung zu schalten, bevor Reparaturen an einem Gerät vorgenommen werden, dessen Chassis unter Spannung steht.
- Bei der Durchführung von Servicearbeiten dürfen die ursprünglichen Kabelanschlüsse nicht vertauscht werden. Dies gilt insbesondere für die Anschlüsse im Hochspannungsteil. Hat sich ein Kurzschluß ereignet, dann sind alle Teile, an denen Spuren von Überhitzung sichtbar sind, auszuwechseln.
- Nach Beenden der Servicearbeiten ist sicherzustellen, daß alle Sicherheitsvorrichtungen, wie Isolationsstege, Isolationspapiere, Abschirmungen und Isolations —R/C— Glieder wieder richtig eingesetzt sind.
- Wenn der Fernseher während längerer Zeit nicht in Betrieb gesetzt wird, sollte der Netzstecker aus der Netzsteckdose gezogen werden.
- Im Betrieb sind Spannungen bis zu 29kV in diesem Gerät vorhanden. Die Inbetriebnahme des Fernsehers ohne aufgesetzte Rückwand bringt die Gefahr eines elektrischen Schlages von der Fernseher — Stromversorgung mit sich. Servicearbeiten sollten daher auch nie durch Personen versucht werden, die nicht in vollem Umfang mit den Sicherheitsvorkehrungen beim Umgang mit Hochspannungsgeräten vertraut sind. Vor der Handhabung mit der Bildröhre ist die Anode der Bildröhre immer an dem Empfängerchassis zu entladen.
6. Nach Beenden der Servicearbeiten sind die folgenden Kriechstrom—Prüfungen durchzuführen, um den Kunden vor der Gefahr eines elektrischen Schlages zu schützen.

### MESSUNG DES ISOLATIONSWIDERSTANDES IM ABGESCHALTETEN ZUSTAND

1. Den Netzstecker aus der Netzsteckdose ziehen und die beiden Steckerstifte kurzschließen.
- Den Geräteschalter des Fernsehgerätes einschalten.
- Mit einem Ohmmeter den Widerstandswert zwischen dem überbrückten Netzstecker und jedem zugänglichen Metallteil am Gehäuse des Fernsehgerätes, wie Schraubenköpfe, Antennen, Achsen der Regler, Griffassungen usw messen. Wenn ein zugängliches Metallteil keine Rückleitung zum Chassis hat, muß die Anzeige unendlich betragen.

## LEAKAGE CURRENT HOT CHECK

1. Plug the AC cord directly into the AC outlet. Do not use an isolation transformer for this check.
2. Connect a  $2k\Omega$  10W resistor in series with an exposed metallic part on the receiver and an earth such as a water pipe.
3. Use an AC voltmeter with high impedance to measure the potential across the resistor.
4. Check each exposed Metallic part and check the voltage at each point.
5. Reverse the AC plug at the outlet and repeat each of the 4. above measurements.
6. The potential at any point should not exceed 1.4 Vrms. In 5. case a measurement is outside the limits specified, there is a possibility of a shock hazard, and the receiver should be repaired and rechecked before it is returned to the customer.

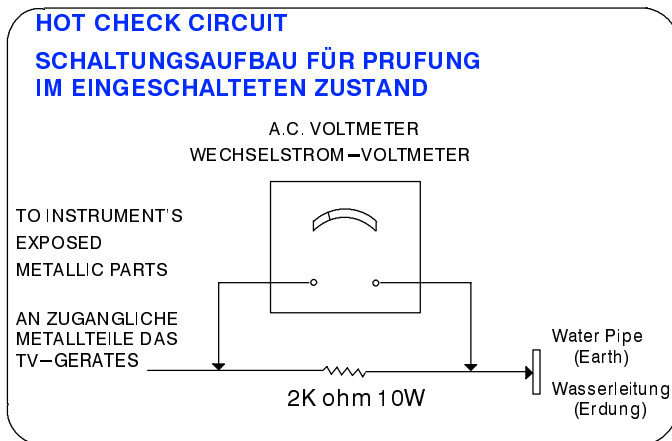

Fig.1.  
Abb.1.

## X-RADIATION WARNING

1. The potential sources of X-Radiation in TV sets are the high voltage section and the picture tube.
2. When using a picture tube test jig for service ensure that the jig is capable of handling 29kV without causing X-Radiation.

**NOTE** : It is important to use an accurate periodically calibrated high voltage meter

1. Set the brightness to minimum.
2. Measure the high voltage. The meter should indicate  $28kV \pm 1kV$  if the meter indication is out of tolerance, immediate service and correction is required to prevent the possibility of premature component failure.
3. To prevent any X-Radiation possibility, it is essential to use the specified tube.

## MESSUNG DES KRIECHSTROMS IM EINGESCHALTETEN ZUSTAND

1. Den Netzstecker direkt in eine Netsteckdose stecken. Für diese Messung keinen Trenntransformator verwenden.
2. Einen  $2k\Omega$  / 10W-Widerstand in Serie mit einem von außen zugänglichen Metallteil am Fernsehgerät und einer guten, Erdung z.B Wasserleitung, anschließen.
3. Ein Wechselstrom-Voltmeter mit einem Meßbereich von 1000 Ohm.Volt oder größer verwenden, um die Spannung über den Widerstand zu messen.
4. Jedes zugängliche Metallteil prüfen, und an jedem Punkt die Spannung messen.
5. Den Netzstecker umgekehrt in die Steckdose stecken und jede der obigen Messungen wiederholen.
6. Die Spannung darf an keinem der Punkte 1.4V eff. überschreiten. Wird dieser Wert nicht eingehalten, besteht die Gefahr eines elektrischen Schlages, und das Fernsehgerät sollte daher repariert und nachgeprüft werden, bevor es an den Kunden zurückgegeben wird.

## RÖNTGENSTRAHLUNG ACHTUNG :

1. Potentielle Quellen von Röntgenstrahlung in Fernsehgeräten sind das Hochspannungsteil und die Bildröhre.
2. Bei Verwendung eines Bildröhren-Prüfgerätes für den Service ist sicherzustellen, daß es für die Belastung von 29kV geeignet ist, ohne daß eine Röntgenstrahlung verursacht wird.

**ANMERKUNG** : Es ist wichtig, daß ein präzises, regelmäßig geprüfetes Voltmeter verwendet wird.

1. Helligkeit auf Minimum stellen.
  2. Die Hochspannung messen. Die Anzeige des Instrumentes sollte  $28kV \pm 1kV$  betragen. Falls die Anzeige diese Toleranzgrenzen überschreitet, ist die sofortige Behebung nötig, um die Möglichkeit vorzeitigen Komponentenausfalls zu verhüten.
- Um die Möglichkeit von Röntgenstrahlung zu begrenzen, ist es wichtig, daß nur die vorgeschriebene Bildröhre verwendet wird.

## SERVICE HINTS

### HOW TO REMOVE THE REAR COVER

1. Remove the 6 screws (A) as shown in **Fig.2./Fig.3.**

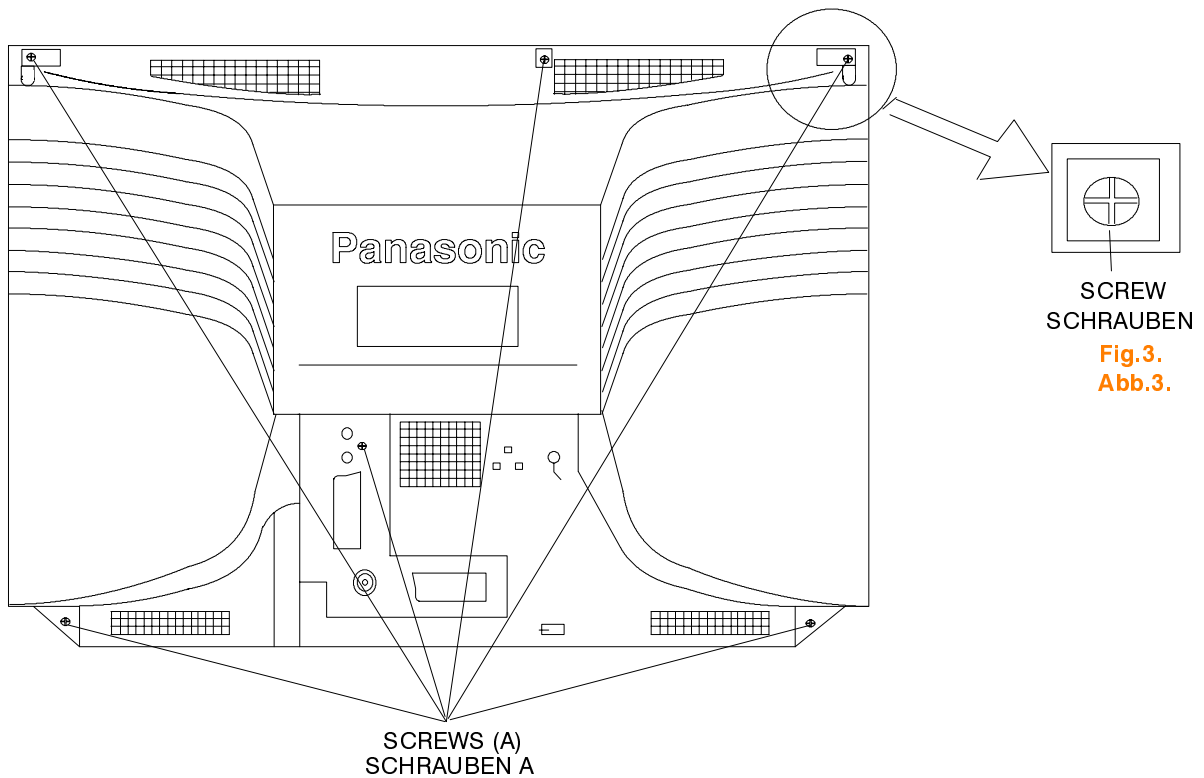

**Fig.2.**  
**Abb.2.**

SCREW  
SCHRAUBEN

**Fig.3.**  
**Abb.3.**

## LOCATION OF CONTROLS

## LAGE DER EINSTELLREGLER

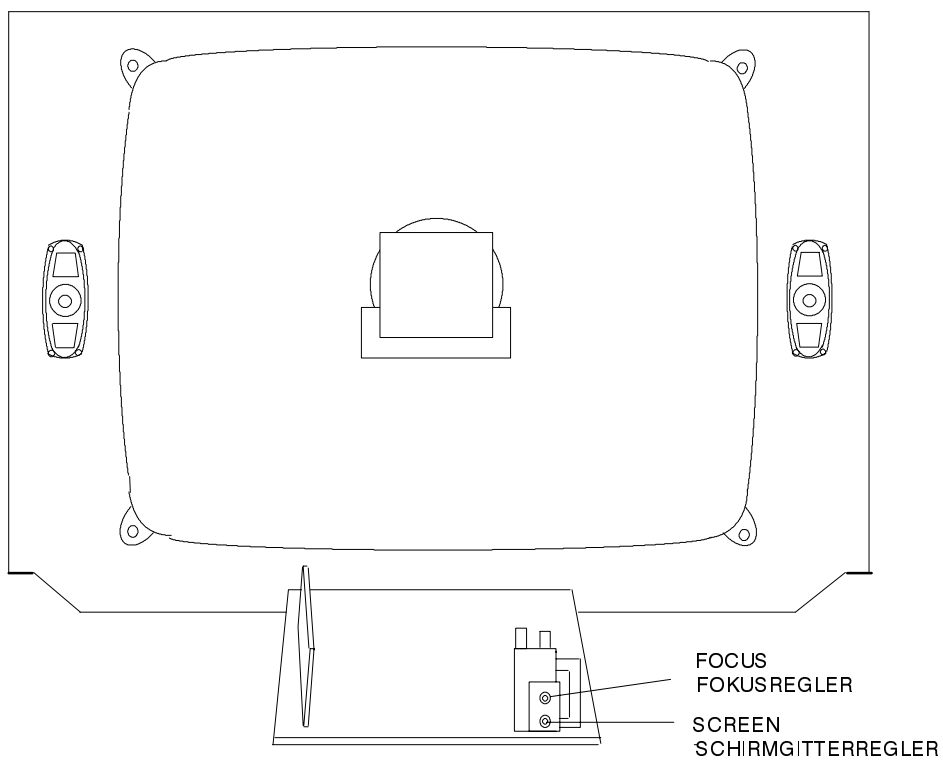

**Fig.4.**  
**Abb.4.**

## ADJUSTMENT PROCEDURE

The remote control is used for entering and storing adjustments, with the exception of cut-off adjustments which must always be done prior to service adjustment. Perform adjustments in accordance with screen display. The display on the screen also specifies the CCU variants as well as the approx. setting values. The adjustment sequence for the service mode is indicated below.

1. Set the Bass to maximum position, set the Treble to 3. minimum position, press and hold the Reveal button on the remote control and at the same time press the  $\text{—/V}$  button on the customer controls at the front of the TV, this will place the TV into the Service Mode.
2. Press the RED / GREEN buttons to step up / down through the functions.
3. Press the YELLOW / BLUE buttons to alter the function values.
4. Press the STORE button after each adjustment has been made to store the required values.
5. To exit the Service Mode press the Normalisation button.

**NOTE:** This TV also has the option of using a Memory Pack which enables you to copy the preset TV channels into the Memory Pack and then download them onto this or any other EURO-2 TV set.

### TV to Memory Pack process

1. Plug the memory pack into the lower of the two 21 pin terminals at the back of the TV and switch the TV on. If the TV has only one 21 pin connector then this will be able to accept the memory pack.
2. Go into the Service Mode as explained above. The screen will show:—

Program  
External >> TV

3. Press the blue button on the remote control. The screen will show:—

Program  
TV >> External

4. Press the STORE button on the TV. The screen will show:—

Storing

5. All the tuning information stored inside the TV will now be transferred to the Memory Pack. This process will take 2–3 minutes to complete and when finished the screen will show:—

OK!

### Memory Pack to TV Process

1. Plug the memory pack into the lower of the two 21 pin terminals at the back of the TV and switch the TV on. If the TV has only one 21 pin connector then this will be able to accept the memory pack.
2. Go into the Service Mode as explained above. The screen will show:—

Program  
External >> TV

3. Press the STORE button on the TV. The screen will show:—

Loading

4. All the tuning information stored inside the Memory Pack will now be transferred to the TV. This process will take 2–3 minutes to complete and when finished the screen will show:—

OK!

5. The tuning information from the Memory Pack has now been copied into the TV

6. To exit from the Service Mode press the Normalisation button.

7. The process has now been completed and the Memory Pack can now be removed.

## Errors

If an error occurs while using the Memory Pack the TV will detect this and the screen will show:—

Program  
Error!

If this happens then press the Normalisation button and repeat the process that was being used. If the errors continue to occur then check the connectors between the TV and the memory pack and check the 9V battery inside the memory pack.

# ABGLEICHVERFAHREN

Die Fernbedienung dient zum Eingeben und Abspeichern der Einstellwerte, mit Ausnahme der Sperrpunkteinstellung, die grundsätzlich vor den hier beschriebenen Einstellungen vorgenommen werden muss. Die Einstellung erfolgt entsprechend dem Bildschirm-Display. Auf dem Bildschirm-Display erscheinen auch die CCU-Varianten sowie die ungefähren Einstellwerte. Die Einstellfolge für den Service-Modus ist nachstehend beschrieben.

1. Um in den Service-Mode zu gelangen, gehen sie bitte 3. wie folgt vor.
  - a) Stellen sie im Toneinstellungs-Menü die Bässe auf 4, Maximum und die Höhen auf Minimum.
  - b) Halten sie die REVEAL-Taste auf der Fernbedienung gedrückt und drücken zusätzlich die Taste -/v im 5. Bedienteil des TV-Gerätes. Auf dem Bildschirm erscheint die entsprechende Anzeige für den Service-Mode.
2. Die einzelnen Funktionen mit Hilfe der ROTEN und GRÜNEN Taste anwählen.

Mit der GELBEN und BLAUEN Taste die Werte der einzelnen Funktionen ändern.  
 Nach jeder Einstellung die Taste STR auf der Fernbedienung oder am Bedienfeld drücken, um die geänderten Werte abzuspeichern.  
 Zum Verlassen des Service-Modus die "N"-Taste auf der Fernbedienung drücken

**HINWEIS:** Dieses FS-Gerät bietet auch die Möglichkeit eines Memory Pack, mit dem Sie die gewählten Fernsehkanäle abspeichern und auf jedes beliebige EURO2 FS-Gerät umkopieren können.

## Kopieren der Einstelldaten vom FS-Gerät in das Memory Pack Kopieren der Einstelldaten vom Memory Pack in das FS-Gerät

1. Das Memory Pack in die untere der beiden 21-poligen 1. Steckerleisten an der Rückseite des FS-Geräts stecken und das Gerät einschalten. Wenn das FS-Gerät nur eine 21-polige Anschlussleiste hat, kann das Memory Pack auch an diese angeschlossen werden.
2. Wie schon oben beschrieben auf Service-Modus 2. umschalten. Auf dem Bildschirm erscheint: –

Program  
 External>>TV

3. Nun die blaue Taste an der Fernbedienung betätigen. Auf 3. dem Bildschirm erscheint: –

Program  
 TV>>External

4. Die Taste STORE am Fernseher drücken. Der Bildschirm 4. meldet nun:–

Storing

5. Die im FS-Gerät abgespeicherten Kanal-Einstelldaten werden nun in das Memory Pack überspielt. bei abgeschlossener Datenübertragung meldet der 5. Bildschirm:–

OK!

1. Das Memory Pack in die untere der beiden 21-poligen Steckerleisten an der Rückseite des FS-Geräts stecken und das Gerät einschalten. Wenn das FS-Gerät nur eine 21-polige Anschlussleiste hat, kann das Memory Pack auch an diese angeschlossen werden.
2. Wie schon oben beschrieben auf Service-Modus umschalten. Auf dem Bildschirm erscheint: –

Program  
 External>>TV

3. Die Taste STORE am Fernseher drücken. Der Bildschirm meldet nun: –

Loading

4. Die im Memory Pack abgespeicherten Einstelldaten werden nun in das FS-Gerät überspielt. bei abgeschlossener Datenübertragung meldet der Bildschirm:–

OK!

5. Die Kanal-Einstelldaten sind damit vom Memory Pack in das FS-Gerät überspielt.

6. Zum Verlassen des Service-Modus die "N"-Taste auf der Fernbedienung drücken
7. Der Kopiervorgang ist somit abgeschlossen, und das Memory Pack kann von der Steckerleiste abgezogen werden.

## Fehler

Falls beim Gebrauch des Memory Packs Fehler auftreten, zeigt das FS-Gerät dies auf dem Bildschirm mit der folgenden Meldung an:–

Program  
 Error!

In diesem Fall muss der Service-Modus durch Drücken der "N"-Taste auf der Fernbedienung verlassen und anschließend der Vorgang wiederholt werden. Falls weiterhin Fehlermeldungen erscheinen, müssen die Anschlusskontakte zwischen FS-Gerät und Memory Pack sowie die 9V Batterie im Memory Pack kontrolliert werden.



## ADJUSTMENT PROCEDURE

Item/Preparation	Adjustments
<b>+B SET-UP</b> 1. Receive a test pattern 2. Set the controls: Brightness      minimum Contrast         minimum Volume           minimum	1. Set the +B voltage up as follows: Adjust <b>R811</b> so that <b>B2</b> shows $147V \pm 1V$ 2. Confirm the following voltages. <b>B1</b> $203 \pm 10V$ <b>B6</b> $12 \pm 0.5V$ <b>B3</b> $27 \pm 1V$ <b>B7</b> $5 +0.1/-0.25V$ <b>B4</b> $35.5 \pm 1V$ <b>B8</b> $5 \pm 0.25V$ <b>B5</b> $15.5 \pm 1V$ <b>U33</b> $31 \pm 1V$
<b>RF AGC</b> 1. Receive a test pattern. 2. Connect an oscilloscope between the tuner RF AGC and ground. 3. Set the oscilloscope gain range to 1V/div.	1. Check that the noise becomes large when the RF AGC VR <b>R126</b> is turned counterclockwise. After the check turn it clockwise. 2. Gradually turn the RF AGC VR anti-clockwise, and set the RF AGC VR to the point where the RF AGC voltage is just falling to a point where this voltage drops by 0.2V from the maximum value.
<b>CUT OFF</b> 1. Receive a test pattern. 2. Degauss the tube externally. 3. Set the TV into Service Mode 1. 4. Select Cutoff DC mode.	1. Confirm then value is 128 and select Ug2 mode noting colour with largest value. 2. Turn the screen VR until a colour reaches 20~30. 3. Connect an oscilloscope to the cathode with the biggest value colour. 4. Select Cutoff DC mode and adjust Cutoff pulse to $159V \pm 5V$ . 5. Disconnect the oscilloscope and adjust the screen to whichever colour reaches $70 \pm 30$ first.

## ABGLEICH

Vorbereitung	Abgleich
<b>+B – Abgleich</b> 1. Testbild empfangen. 2. Helligkeit auf Minimum Kontrast auf Minimum Lautstärke auf Minimum	1. Mit <b>R611</b> muß die <b>B2</b> auf $147V \pm 1V$ eingestellt werden. 2. Folgende Spannungen sind zu überprüfen : <b>B1</b> $203 \pm 10V$ <b>B6</b> $12 \pm 0.5V$ <b>B3</b> $27 \pm 1V$ <b>B7</b> $5 +0.1/-0.25V$ <b>B4</b> $35.5 \pm 1V$ <b>B8</b> $5 \pm 0.25V$ <b>B5</b> $15.5 \pm 1V$ <b>U33</b> $31 \pm 1V$
<b>RF AGC</b> 1. Testbild empfangen. 2. An die Tuner RF AGC und Masse ein Oszilloskop anschließen. 3. Die Empfindlichkeit des Oszilloskopes auf 1V/div. einstellen.	1. Wenn das Poti <b>R126</b> (RF AGC) gegen den Uhrzeigersinn gedreht wird. muß das Rauschen zunehmen. 2. Das Poti R126 gegen den Uhrzeigersinn so einstellen, daß die eingestellte Spannung um 0,2V unter dem Maximalwert.
<b>CUT OFF</b> 1. Testbild empfangen. 2. Bildröhre entmagnetisieren. 3. Service-Mode 1 anwählen. 4. Im Service-Mode den Abgleichpunkt Cutoff DC-Mode wählen (14).	1. Im Feld Cutoff DC muß der Wert 128 stehen, Im Ug2-Feld muß Farbe mit dem höchstem Wert notiert werden. 2. Mit dem Screen-Poti wird die Farbe auf 20 bis 30 eingestellt. 3. An die Kathode mit den höchsten Wert (aus Punkt 1) wird ein Oszilloskop angeschlossen. 4. Im Cutoff DC Mode wird der Cutoff-Puls auf $159V \pm 5V$ eingestellt. 5. Das Oszilloskop entfernen und im Cutoff Mode die Werte so einstellen, daß sie alle bis $70 \pm 30$ liegen.

## ALIGNMENT SETTINGS (The figures used below are nominal and used for representative purposes only)

Alignment Function		Settings / Special features
1. Vertical amplitude	V-AMP 054	Optimum setting.
2. Vertical symmetry	V-SYM 002	
3. Vertical linearity	V-LIN 006	
4. Vert. DC.	Vert. D.C. 000	Not to be adjusted.
5. V-Pos	V. Pos. 005	Optimum setting.
6. Horizontal amplitude	H-AMP 055	Optimum setting.
7. Horizontal position	H-POS 061	
8. Text Position	TEXT POSITION 048	Optimum setting.
9. EW-amplitude	E-W-AMP 1 -128	Optimum setting.
10. EW-amplitude	E-W-AMP 2 006	Optimum setting.
11 Trapezium-comp	TRAPEZ-1 047	Optimum setting.
12. Trapezium-comp	TRAPEZ-2 -128	Optimum setting.
13. Colour VCO	Colour VCO -005	Press either Blue or Yellow buttons to effect automatic adjustment.
14. Cut-off DC	Cut-off DC 171	Not to be adjusted.
15. Ug2 Test	Ug 2 Test 006    055    059	Select Cutoff DC in Service Mode mode and confirm the value is 128. Select Ug 2 Test noting colour with largest value, adjust on FBT until a colour reaches 20 ~ 30. Connect an oscilloscope to the cathode of the biggest value colour, select Cutoff DC mode and adjust get Cutoff pulse voltage to 159±5V. Disconnect the oscilloscope and adjust the screen to whichever colour reaches 70±30 first.
16. Cutoff	Cutoff 034    052    056	Press the GREEN button to step through the settings. Adjust for optimum.
17. White	White 216    255    216	Press the GREEN button to step through the settings. Adjust for optimum.

# ABGLEICHTABELLE

(Die angegebenen Werte sind Mittelwerte und Können individuell nach oben oder unten nach dem korrekten Abgleich abweichen)

Abgleichfunktion		Einstellung/Besondere Merkmale						
1. Vertikale Amplitude	<table border="1" style="width: 100%; text-align: center;"> <tr><td>V-AMP</td></tr> <tr><td>054</td></tr> </table>	V-AMP	054	Optimale Einstellung.				
V-AMP								
054								
2. Vertikale symmetrie	<table border="1" style="width: 100%; text-align: center;"> <tr><td>V-SYM</td></tr> <tr><td>002</td></tr> </table>	V-SYM	002					
V-SYM								
002								
3. Vertical linearität	<table border="1" style="width: 100%; text-align: center;"> <tr><td>V-LIN</td></tr> <tr><td>006</td></tr> </table>	V-LIN	006					
V-LIN								
006								
4. Vert. DC	<table border="1" style="width: 100%; text-align: center;"> <tr><td>Vert. D.C.</td></tr> <tr><td>000</td></tr> </table>	Vert. D.C.	000	Nicht einstellen.				
Vert. D.C.								
000								
5. V-Pos	<table border="1" style="width: 100%; text-align: center;"> <tr><td>V. Pos.</td></tr> <tr><td>005</td></tr> </table>	V. Pos.	005	Optimale Einstellung.				
V. Pos.								
005								
6. Horizontale Amplitude	<table border="1" style="width: 100%; text-align: center;"> <tr><td>H-AMP</td></tr> <tr><td>055</td></tr> </table>	H-AMP	055	Optimale Einstellung.				
H-AMP								
055								
7. Horizontale position	<table border="1" style="width: 100%; text-align: center;"> <tr><td>H-POS</td></tr> <tr><td>061</td></tr> </table>	H-POS	061					
H-POS								
061								
8. Text Position	<table border="1" style="width: 100%; text-align: center;"> <tr><td>TEXT POSITION</td></tr> <tr><td>048</td></tr> </table>	TEXT POSITION	048	Optimale Einstellung.				
TEXT POSITION								
048								
9. OW-amplitude	<table border="1" style="width: 100%; text-align: center;"> <tr><td>E-W-AMP 1</td></tr> <tr><td>-128</td></tr> </table>	E-W-AMP 1	-128	Optimale Einstellung.				
E-W-AMP 1								
-128								
10. OW-amplitude	<table border="1" style="width: 100%; text-align: center;"> <tr><td>E-W-AMP 2</td></tr> <tr><td>006</td></tr> </table>	E-W-AMP 2	006	Optimale Einstellung.				
E-W-AMP 2								
006								
11. Trapez-Kompensation	<table border="1" style="width: 100%; text-align: center;"> <tr><td>TRAPEZ-1</td></tr> <tr><td>047</td></tr> </table>	TRAPEZ-1	047	Optimale Einstellung.				
TRAPEZ-1								
047								
12. Trapez-Kompensation	<table border="1" style="width: 100%; text-align: center;"> <tr><td>TRAPEZ-2</td></tr> <tr><td>-128</td></tr> </table>	TRAPEZ-2	-128	Optimale Einstellung.				
TRAPEZ-2								
-128								
13. Colour VCO	<table border="1" style="width: 100%; text-align: center;"> <tr><td>Colour VCO</td></tr> <tr><td>-005</td></tr> </table>	Colour VCO	-005	Optimale Einstellung.				
Colour VCO								
-005								
14. Cut-off DC	<table border="1" style="width: 100%; text-align: center;"> <tr><td>Cut-off DC</td></tr> <tr><td>171</td></tr> </table>	Cut-off DC	171	Nicht einstellen.				
Cut-off DC								
171								
15. Bildschirm	<table border="1" style="width: 100%; text-align: center;"> <tr><td colspan="3">Ug 2 Test</td></tr> <tr> <td style="width: 33%;">006</td> <td style="width: 33%;">055</td> <td style="width: 33%;">059</td> </tr> </table>	Ug 2 Test			006	055	059	Wählen Sie den Cutoff DC Im Service Mode und bestätigen Sie den Wert 128. Im Ug2-Feld muß die Farbe mit dem höchsten Wert notiert werden. Mit dem Screen-Poti wird die Farbe auf 20 bis 30 eingestellt. An die Kathode mit den höchsten Wert (aus Punkt 1) wird ein Oszilloskop angeschlossen. Im Cutoff DC Mode wird der Cutoff-Puls auf $159V \pm 5V$ eingestellt. Das Oszilloskop entfernen und im Cutoff Mode die Werte so einstellen, daß sie alle bis $70 \pm 30$ liegen.
Ug 2 Test								
006	055	059						
16. Cutoff	<table border="1" style="width: 100%; text-align: center;"> <tr><td colspan="3">Cutoff</td></tr> <tr> <td style="width: 33%;">034</td> <td style="width: 33%;">052</td> <td style="width: 33%;">056</td> </tr> </table>	Cutoff			034	052	056	Die Einstellungen mit Hilfe der GRÜNEN Taste anwählen. Optimale Einstellung.
Cutoff								
034	052	056						
17. White	<table border="1" style="width: 100%; text-align: center;"> <tr><td colspan="3">White</td></tr> <tr> <td style="width: 33%;">216</td> <td style="width: 33%;">255</td> <td style="width: 33%;">216</td> </tr> </table>	White			216	255	216	Die Einstellungen mit Hilfe der GRÜNEN Taste anwählen. Optimale Einstellung.
White								
216	255	216						

## SELF CHECK

Self check is used to automatically check the Bus Lines and Hexadecimal code of the TV set.

To get into the Self Check mode press the F button followed by the volume down button on the customer controls at the front of the TV at the same time pressing the Status button, on the Remote Control, and the screen will show: –

## SELBSTDIAGNOSE

1) Die Selbstdiagnose dient zum automatischen Prüfen der Bus-Leitungen sowie des Hexadezimalcodes des FS-Geräts.

Zum Umschalten auf Selbstdiagnose nach dem Drücken der "F"-Taste die "Lautstärke Minus" Taste am Bedienfeld des FS-Geräts und gleichzeitig die Taste "Status" an der Fernbedienung drücken; auf dem Bildschirm erscheint hierauf: –

2) Nach der Selbstdiagnose wird das Gerät automatisch auf sämtliche werksseitigen Standardeinstellungen zurückgesetzt: –

1	— ok	Tuner	11	— --	Dolby IC for C/R
2	— ok	VIF	12	— ok	P S MODE
3	— ok	EEPROM	13	— ok	P TA0
4	— --	Sound AV switch1	14	— ok	P TA1
5	— ok	Video AV switch1	15	— ok	P TA2
6	— ok	VDP	16	— ok	P TA3
7	— ok	TPU	17	— ok	P SDA
8	— ok	MSP	18	— ok	P SCL1
9	— --	Dolby Sub	19	— ok	P SCL3
10	— --	Dolby IC for L/R	20	— ok	P SCL4

1	— ok	Tuner	11	— --	Dolby IC for C/R
2	— ok	ZF-Verstärker	12	— ok	P S MODE
3	— ok	EEPROM	13	— ok	P TA0
4	— --	Audio AV-Schalter 1	14	— ok	P TA1
5	— ok	Video AV switch1	15	— ok	P TA2
6	— ok	Video AV-Schalter 1	16	— ok	P TA3
7	— ok	Video AV-Schalter 2	17	— ok	P SDA
8	— ok	MSP	18	— ok	P SCL1
9	— --	Dolby Sub	19	— ok	P SCL3
10	— --	Dolby IC for L/R	20	— ok	P SCL4

If the CCU ports have been checked and found to be incorrect then "--" will appear in place of "OK".

Wenn der Hauptprozessor (CCU) an den Anschlüssen einen Fehler finden sollte, oder der Anschluss nicht belegt ist, zeigt die entsprechende Position -- anstelle von OK an.

21	— ok	P SBLED	Hex codes	7A
22	— ok	P OFF		22
23	— ok	P DEFL		62
24	— ok	P RAM		54
				85

21	— ok	P SBLED	Hexadezimalcode	7A
22	— ok	P OFF		22
23	— ok	P DEFL		62
24	— ok	P RAM		54
				85

# VIDEO BLOCK DIAGRAM    BILD SIGNAL BLOCKSCHEMA

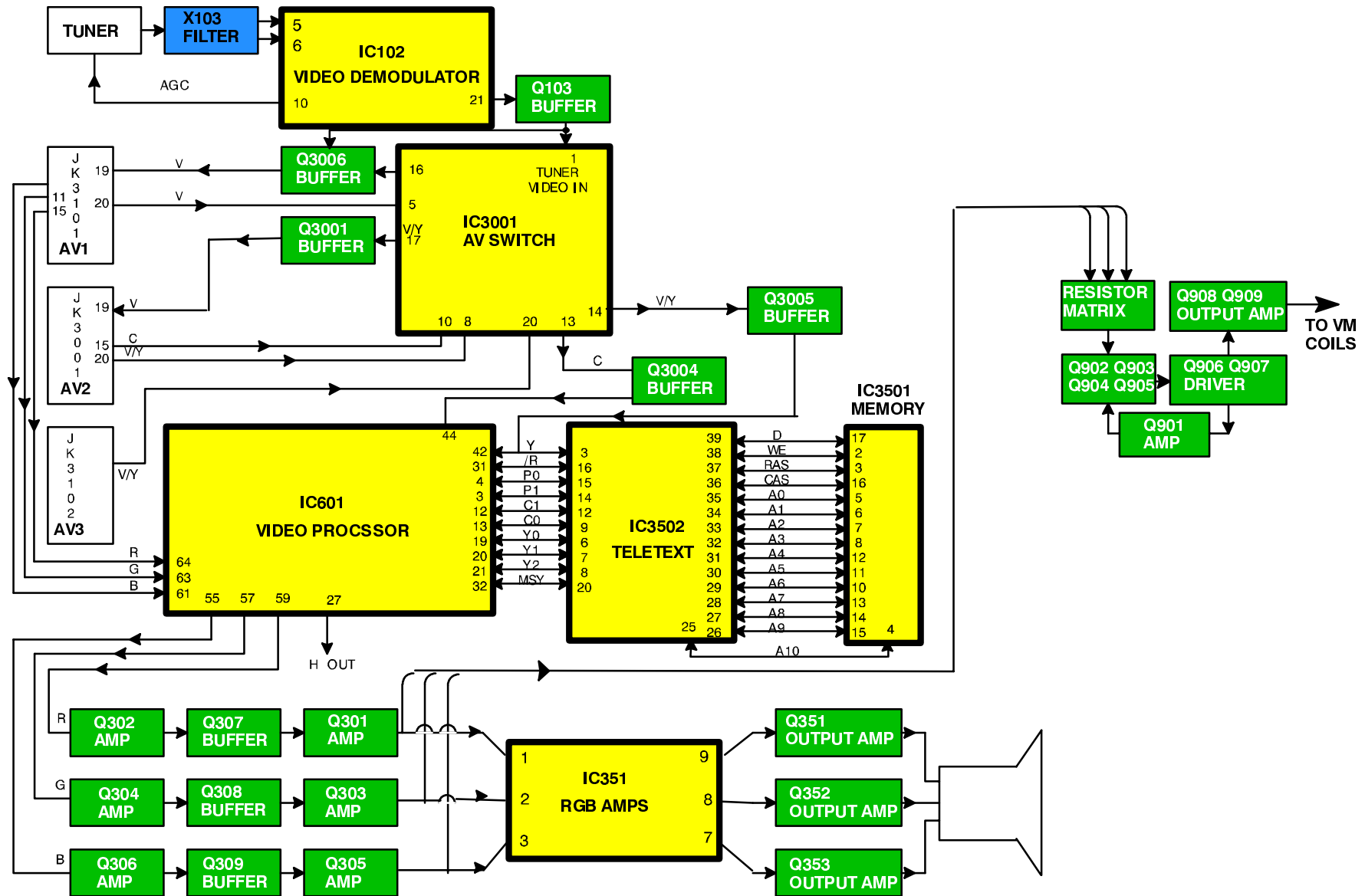

# AUDIO BLOCK DIAGRAM

# TONSIGNAL BLOCKSCHEMA

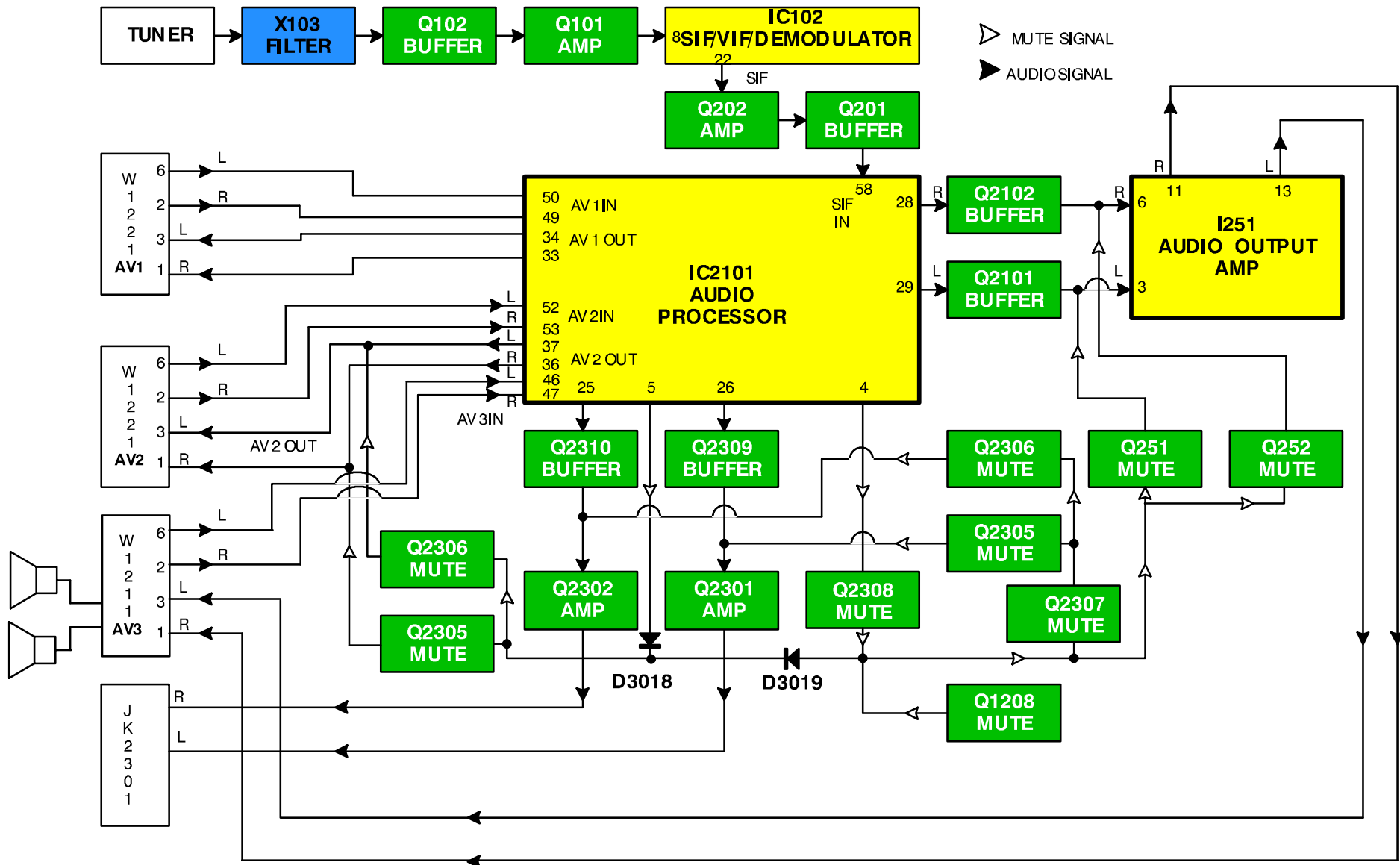

# POWER SUPPLY AND CONTROL BLOCK DIAGRAM STROMVERSORGUNGS BLOCKSCHEMA

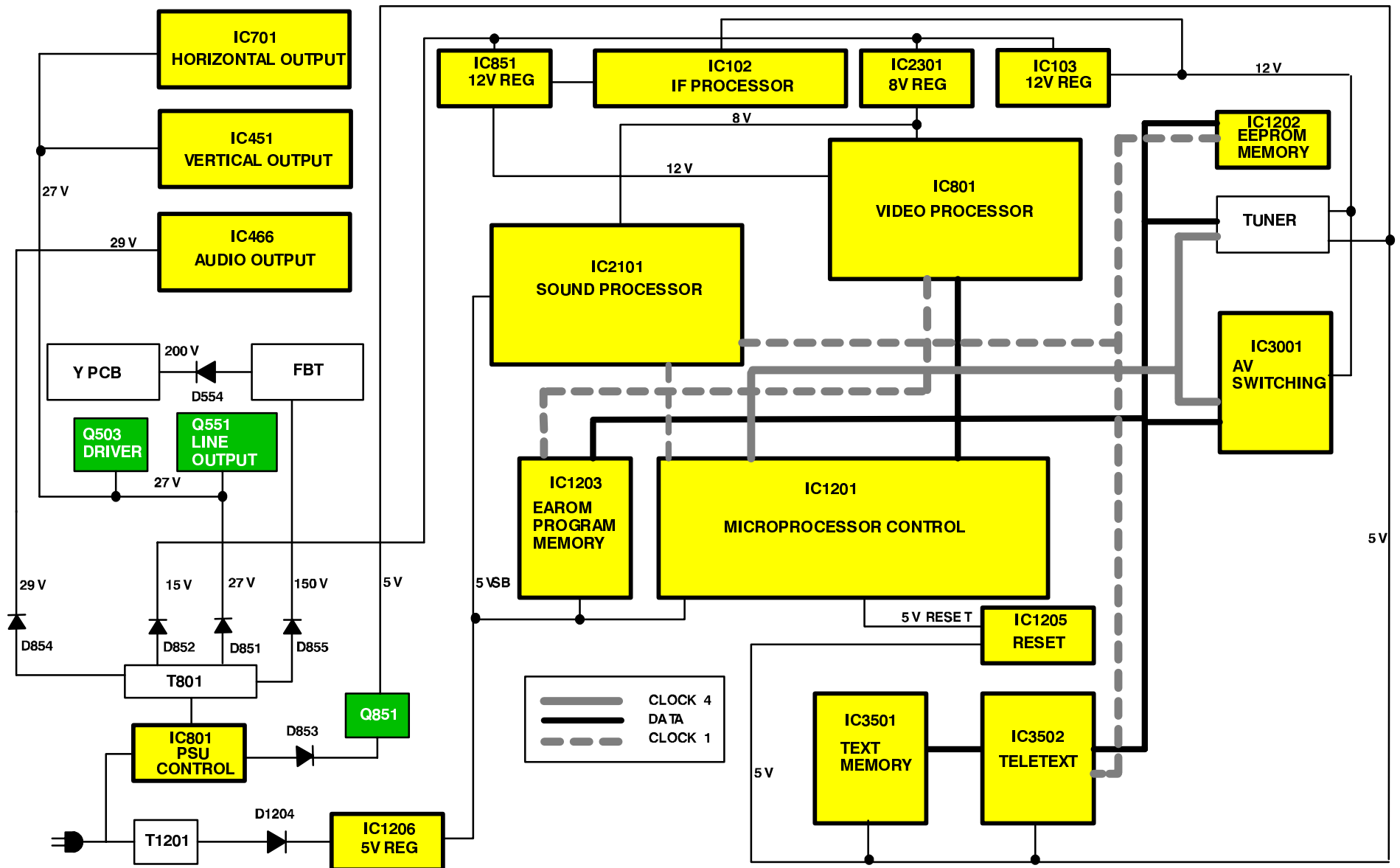

# WAVEFORM PATTERN TABLE

## SIGNAL TABELLE

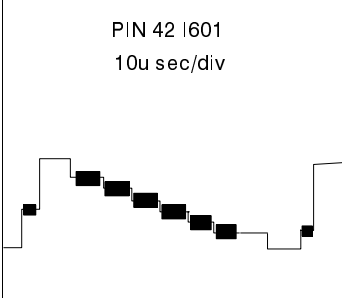
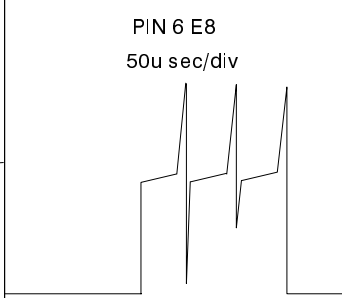
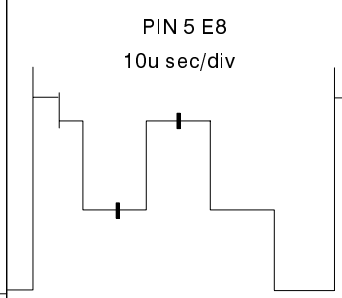
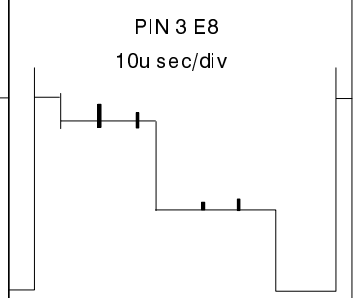
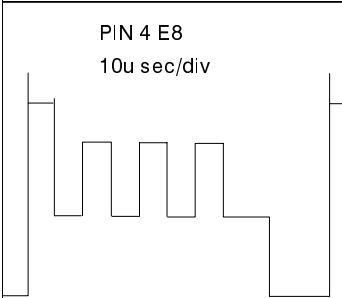
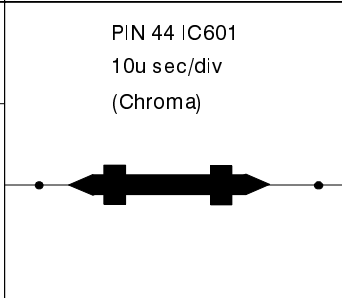
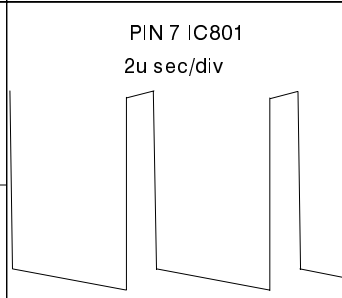
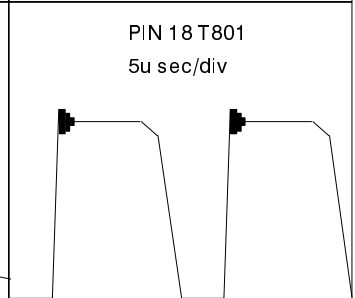
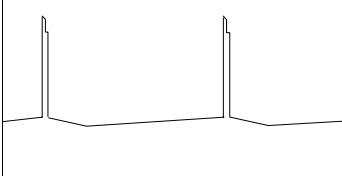
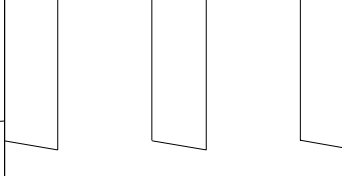
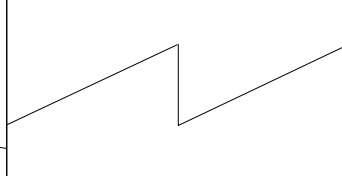
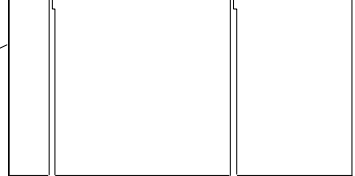
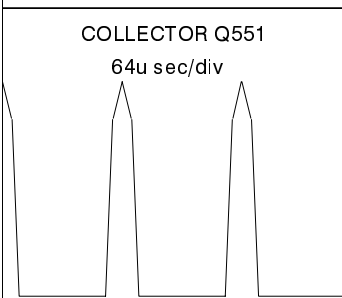
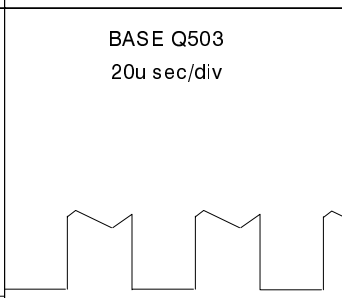
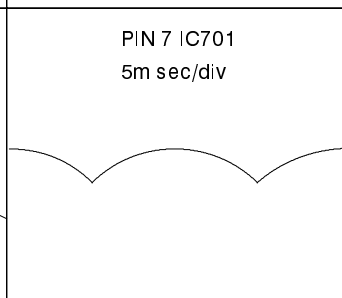
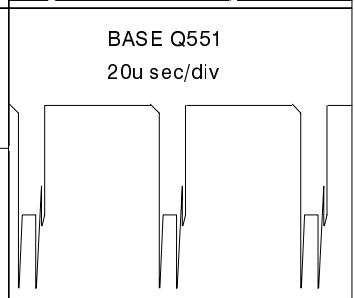
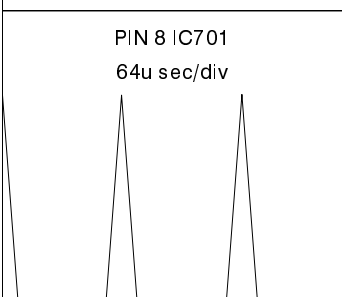
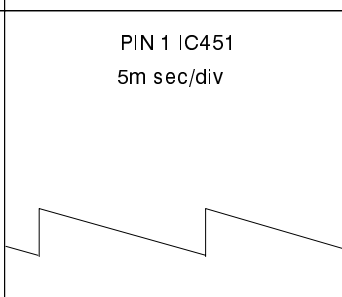
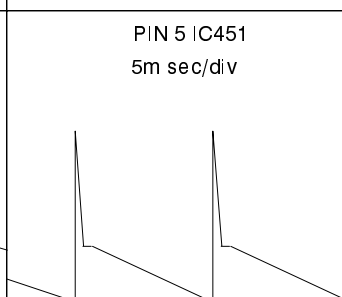
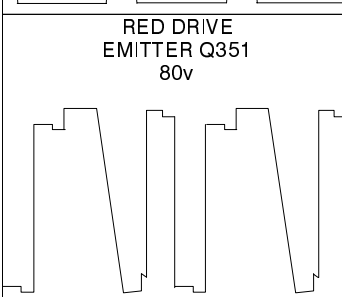
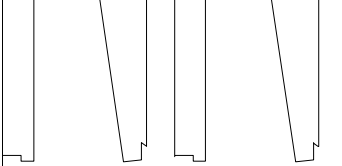
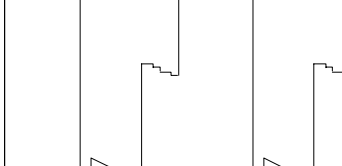
<p>PIN 42 I601 10u sec/div</p> 	<p>PIN 6 E8 50u sec/div</p> 	<p>PIN 5 E8 10u sec/div</p> 	<p>PIN 3 E8 10u sec/div</p> 
<p>PIN 4 E8 10u sec/div</p> 	<p>PIN 44 IC601 10u sec/div (Chroma)</p> 	<p>PIN 7 IC801 2u sec/div</p> 	<p>PIN 18 T801 5u sec/div</p> 
<p>PIN 6 IC451 5m sec/div</p> 	<p>PIN 3 IC801 5u sec/div</p> 	<p>PIN 6 IC601 5m sec/div</p> 	<p>PIN 34 IC601 5m sec/div</p> 
<p>COLLECTOR Q551 64u sec/div</p> 	<p>BASE Q503 20u sec/div</p> 	<p>PIN 7 IC701 5m sec/div</p> 	<p>BASE Q551 20u sec/div</p> 
<p>PIN 8 IC701 64u sec/div</p> 	<p>PIN 1 IC451 5m sec/div</p> 	<p>PIN 5 IC451 5m sec/div</p> 	
<p>RED DRIVE EMITTER Q351 80v</p> 	<p>GREEN DRIVE EMITTER Q352 100v</p> 	<p>BLUE DRIVE EMITTER Q353 120v</p> 	



## PARTS LOCATION

### NOTE :

The numbers on the exploded view below refer to the miscellaneous section of the Replacement Parts List.

## EXPLOSIONSZEICHNUNG

### Anmerking :

Die Nummer auf den mechanischen Teilen zeigt die Bezugsnummer der Ersatzteilliste an.

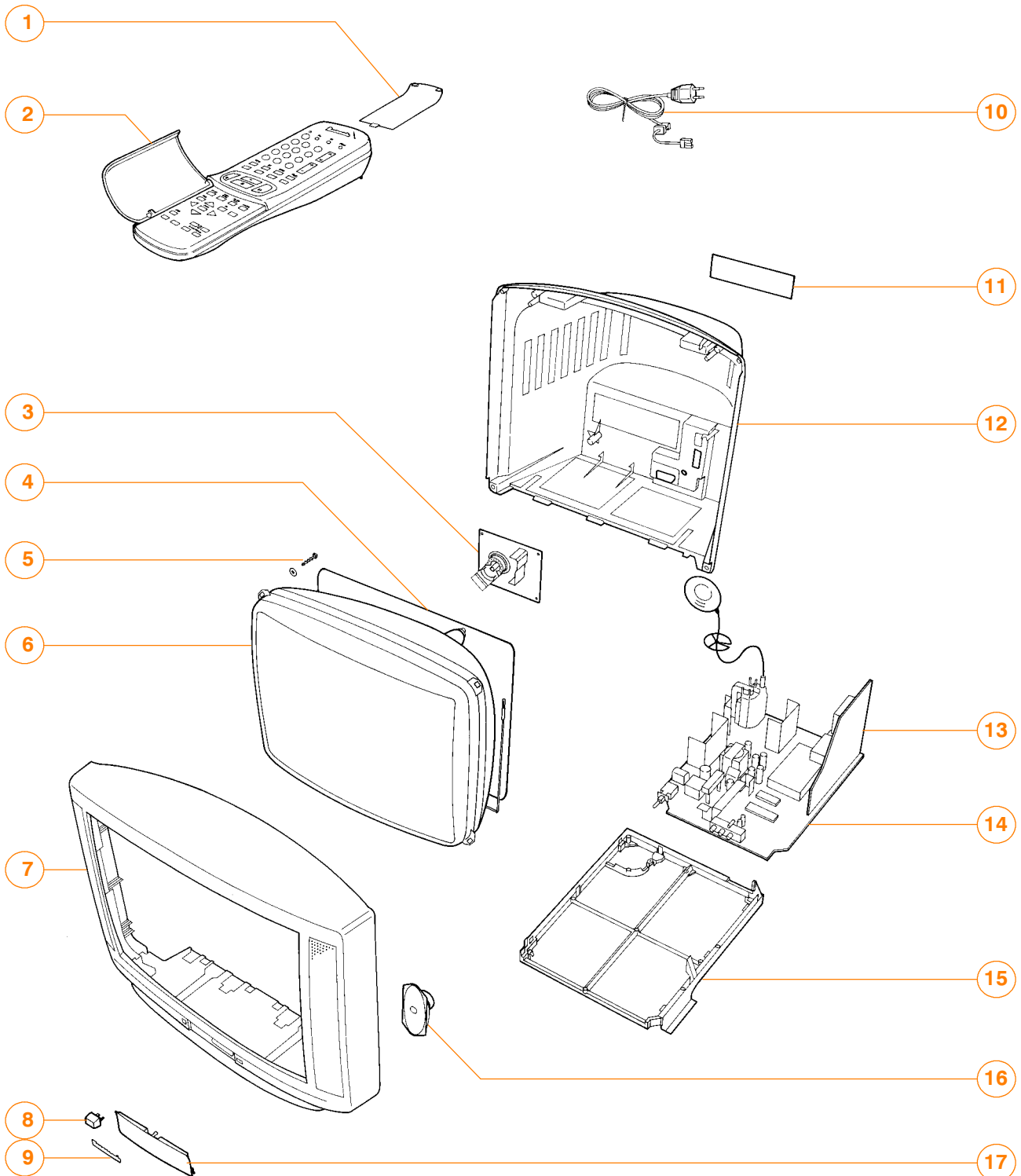

## REPLACEMENT PARTS LIST

### Important Safety Notice

Components identified by ▲ mark have special characteristics important for safety. When replacing any of these components, use only manufacturer's specified parts.

Ref No.	Part No.	Description
<b>MISCELLANEOUS COMPONENTS</b>		
1)	UR51EC780	BATTERY COVER (REMOTE)
2)	EUR51920	REMOTE CONTROL
3)	TNP117070AC	Y P.C.B. ▲
4)	TLK8E05116	DEGAUSS COIL ▲
5)	THE492-4	CRT FIXING SCREW
6)	A66ECF50X12	CRT ▲
7)	TKY8E042	CABINET ▲
8)	TBX8E027	POWER BUTTON
9)	TBM173052	BADGE
10)	TSX8E0020	POWER CORD ▲
11)	TBM8E1720	MODEL LABEL
12)	TKU8E00200	REAR COVER ▲
13)	TNP117064AD	B P.C.B. ▲
14)	TNP197091BD	E P.C.B. ▲
15)	TMX8E010	CHASSIS FRAME
16)	EASG12D531F2	SPEAKER
17)	TKP8E1219	LID
	ENV578F5G3	TUNER ▲
	F9-4-220	RELAY
	SVM100	COIL
	TBM8E1451-2	INDICATION SHEET
	TEK6935	LID SWITCH
	TKP8E1130	LED COVER
	TLK8E05125	COIL
	TMW8E020	LED HOLDER
	TPC8E4633	OUTERN CARTON
	TPD8E562	CUSHION
	TQB8E2353	INST BOOK ▲
	UM-3DEP-2P	BATTERY
	31221212478	FIX CLIP
	TES4537	SPRING
	TES4537	SPRING
<b>INTEGRATED CIRCUITS</b>		
IC102	LA7577N	V.I.F.
IC103	L78M12MRB	12V REGULATOR
IC1051	RPM-637CBRL	LED RECEIVER
IC1201	CCU3000I-05	CENTRAL CONTROL UNIT
IC1202	27C028-LD2C	EPROM
IC1203	X24C0801 BJ	EAROM
IC1205	MN1280R	RESET
IC1206	L78M05MRB	5V REGULATOR
IC2101	MSP3400	AUDIO PROCESSOR
IC2301	AN78L08TA	8V REGULATOR
IC251	LA4280-TV	AUDIO OUTPUT
IC3001	TEA6415C	VIDEO SWITCH
IC3501	UD61256DC-08	DYNAMIC RAM
IC3502	TPU3040-20	TEXT PROCESSOR
IC351	TDA6103Q-N3	R.G.B.AMPLIFIER
IC451	TDA8175-3	VERTICAL OUTPUT
IC601	VDP3108-29	VIDEO PROCESSOR
IC701	TEA2031A	HORIZONTAL OUTPUT
IC801	TDA4601	POWER SUPPLY
IC851	L78M12MRB	12V REGULATOR

## ERSATZTEILLISTE

### Wichtiger Sicherheitshinweis

Teile, die mit einem Hinweis ▲ gekennzeichnet sind, sind wichtig für die Sicherheit. Sollte ein Auswechsein erforderlich sein, sind unbedingt Originalteile einzusetzen.

Ref No.	Part No.	Description
<b>CAPACITORS</b>		
C001	ECUV1H103ZFX	S.M.CAP 50V 10nF
C002	ECA1HMR33GB	ELECT 50V 0.33µF
C003	ECUV1H104ZFX	S.M.CAP 50V 100nF
C004	ECA1CM221GB	ELECT 16V 220pF
C006	ECA1CM101GB	ELECT 16V 100pF
C007	ECUV1H104ZFX	S.M.CAP 50V 100nF
C009	ECUV1H104ZFX	S.M.CAP 50V 100nF
C109	ECUV1H390JPX	S.M.CAP 50V 39pF
C110	ECUV1H102KBX	S.M.CAP 50V 1nF
C111	ECUV1H683ZFX	S.M.CAP 50V 68nF
C112	ECUV1H150JCX	S.M.CAP 50V 15pF
C113	ECA1CM100GB	ELECT 16V 10pF
C114	ECUV1H270JPX	S.M.CAP 50V 27pF
C115	ECUV1H103ZFX	S.M.CAP 50V 10nF
C116	ECA1CM100GB	ELECT 16V 10pF
C117	ECUV1H103ZFX	S.M.CAP 50V 10nF
C118	ECUV1H103ZFX	S.M.CAP 50V 10nF
C119	ECA1HMR47GB	ELECT 50V 0.47µF
C120	ECUV1H102KBX	S.M.CAP 50V 1nF
C121	ECUV1H103ZFX	S.M.CAP 50V 10nF
C122	ECUV1H151JX	S.M.CAP 50V 150pF
C123	ECUV1H102KBX	S.M.CAP 50V 1nF
C124	ECA1CM470GB	ELECT 16V 47µF
C125	ECUV1H103ZFX	S.M.CAP 50V 10nF
C127	ECA1CM470GB	ELECT 16V 47µF
C128	ECUV1H103ZFX	S.M.CAP 50V 10nF
C130	ECA1HMR47GB	ELECT 50V 0.47µF
C131	ECA1HM2R2GB	ELECT 50V 2.2µF
C132	ECUV1H331KBX	S.M.CAP 50V 330pF
C133	ECUV1H102KBX	S.M.CAP 50V 1nF
C134	ECUV1H103ZFX	S.M.CAP 50V 10nF
C135	ECUV1H103ZFX	S.M.CAP 50V 10nF
C136	ECA1CM100GB	ELECT 16V 10pF
C137	ECA1EM100GB	ELECT 25V 0.1µF
C138	ECUV1H103ZFX	S.M.CAP 50V 10nF
C139	ECUV1H020CCX	S.M.CAP 50V 2pF
C140	ECA1HM010GB	ELECT 50V 1pF
C141	ECUV1H102KBX	S.M.CAP 50V 1nF
C142	ECUV1H102KBX	S.M.CAP 50V 1nF
C143	ECUV1H102KBX	S.M.CAP 50V 1nF
C145	ECA1CM470GB	ELECT 16V 47µF
C201	ECUV1H070DCX	S.M.CAP 50V 7pF
C202	ECUV1H070DCX	S.M.CAP 50V 7pF
C203	ECUV1H470JX	S.M.CAP 50V 47pF
C204	ECUV1H560JCX	S.M.CAP 50V 56pF
C205	ECUV1H100DCX	S.M.CAP 50V 10pF
C207	ECUV1H220JCX	S.M.CAP 50V 22pF
C209	ECUV1H103ZFX	S.M.CAP 50V 10nF
C210	ECUV1H103ZFX	S.M.CAP 50V 10nF
C211	ECUV1H103ZFX	S.M.CAP 50V 10nF
C251	ECA1EM101GB	ELECT 25V 1µF
C252	ECUV1H223KBX	S.M.CAP 50V 22nF
C253	ECA1HM4R7GB	ELECT 50V 4.7µF
C254	222236516684	FILM 160V 100nF
C255	ECEA1EGE101	ELECT 25V 100µF
C256	ECUV1H223KBX	S.M.CAP 50V 22nF
C257	ECA1HM4R7GB	ELECT 50V 4.7µF
C258	ECA1EM101GB	ELECT 25V 1µF
C259	222236516684	FILM 160V 100nF
C260	ECA1VM102GE	ELECT 35V 1nF

Ref No.	Part No.	Description		
C261	ECA1VM102GE	ELECT	35V	1nF
C262	ECQM1H474J	FILM	50V	470nF
C263	ECA1HM010GB	ELECT	50V	1pF
C264	ECEA1HGE222	ELECT	50V	2200µF
C265	ECQM1H474J	FILM	50V	470nF
C266	ECA1HM010GB	ELECT	50V	1pF
C267	ECUV1H104ZFX	S.M.CAP	50V	100nF
C268	ECUV1H104ZFX	S.M.CAP	50V	100nF
C269	ECA1CM100GB	ELECT	16V	10pF
C271	ECUV1H561KBX	S.M.CAP	50V	560pF
C301	ECA1CM470GB	ELECT	16V	47µF
C302	ECUV1H104ZFX	S.M.CAP	50V	100nF
C303	ECUV1H104ZFX	S.M.CAP	50V	100nF
C310	ECUV1H104ZFX	S.M.CAP	50V	100nF
C354	ECQM2104KZ	FILM	250V	100nF
C355	ECUV1H222JCX	S.M.CAP	50V	2.2nF
C356	ECUV1H222JCX	S.M.CAP	50V	2.2nF
C357	ECUV1H222JCX	S.M.CAP	50V	2.2nF
C358	ECQM1H224J	FILM	50V	220nF
C360	ECKC3D152J	CERAMIC	2KV	1.5nF
C361	ECA1HMR47GB	ELECT	50V	0.47µF
C364	ECUV1H103ZFX	S.M.CAP	50V	10nF
C366	ECA1CM100GB	ELECT	16V	10pF
C451	ECUV1H102JX	S.M.CAP	50V	1nF
C452	ECUV1H473ZFX	S.M.CAP	50V	47nF
C453	ECUV1H472KBX	S.M.CAP	50V	4.7nF
C454	ECUV1H104ZFX	S.M.CAP	50V	100nF
C455	ECEA1VGE222	ELECT	35V	2200µF
C456	ECEA1HGE221	ELECT	50V	220µF
C457	ECUV1H223KBX	S.M.CAP	50V	22nF
C458	ECQM1H154J	FILM	50V	150nF
C459	ECQM1H224J	FILM	50V	220nF
C460	ECQV1H105JZ	FILM	50V	1µF
C461	ECQM1H684J	FILM	50V	680nF
C462	ECEA1VGE332	ELECT	35V	3300µF
C501	ECA1AM330GB	ELECT	10V	33pF
C506	ECUV1H103ZFX	S.M.CAP	50V	10nF
C508	ECQV1H105JZ	FILM	50V	1µF
C509	ECEA1HGE101	ELECT	50V	100µF
C510	ECUV1H104ZFX	S.M.CAP	50V	100nF
C511	ECQM2683JZ	FILM	250V	68nF
C551	ECWH15H472J	FILM	1500V	4700µF
C552	ECWH15H102H	FILM	1500V	100pF
C554	ECWF2H514J	FILM	500V	510nF
C555	ECWH12H103J	FILM	1250V	10nF
C556	ECQM4333JC	FILM	400V	33nF
C559	ECWF2H684J	FILM	500V	680nF
C560	ECEA2GGE2R2	ELECT	400V	2.2µF
C562	ECKC2H101J	CERAMIC	500V	100pF
C563	ECEA2EU220	ELECT	250V	22µF
C564	ECEA2AU2R2	ELECT	100V	2.2µF
C565	ECQP1H273J	FILM	100V	2700µF
C601	ECUV1H271JCX	S.M.CAP	50V	270pF
C602	ECUV1H121JCX	S.M.CAP	50V	120pF
C603	ECUV1H471JCX	S.M.CAP	50V	470pF
C604	ECA0JM102GB	ELECT	6.3V	1nF
C605	ECUV1H103ZFX	S.M.CAP	50V	10nF
C608	ECUV1H683ZFX	S.M.CAP	50V	68nF
C609	ECA1CM470GB	ELECT	16V	47µF
C610	ECUV1H683ZFX	S.M.CAP	50V	68nF
C611	ECUV1H104ZFX	S.M.CAP	50V	100nF
C612	ECUV1H103ZFX	S.M.CAP	50V	10nF
C613	ECUV1H102JCX	S.M.CAP	50V	1nF
C614	ECUV1H104ZFX	S.M.CAP	50V	100nF
C615	ECUV1H103ZFX	S.M.CAP	50V	10nF
C616	ECUV1H103ZFX	S.M.CAP	50V	10nF
C618	ECUV1H473ZFX	S.M.CAP	50V	47nF
C619	ECUV1H104ZFX	S.M.CAP	50V	100nF
C620	ECUV1H104ZFX	S.M.CAP	50V	100nF
C621	ECA1CM100GB	ELECT	16V	10pF
C622	ECA1CM100GB	ELECT	16V	10pF
C623	ECUV1H104ZFX	S.M.CAP	50V	100nF

Ref No.	Part No.	Description		
C624	ECUV1H103ZFX	S.M.CAP	50V	10nF
C625	ECEA1HNR22	ELECT	50V	0.22µF
C626	ECA0JM102GB	ELECT	6.3V	1nF
C627	ECUV1H100DCX	S.M.CAP	50V	10pF
C628	ECUV1H470JCX	S.M.CAP	50V	47pF
C629	ECUV1H101JCX	S.M.CAP	50V	100pF
C630	ECUV1H104ZFX	S.M.CAP	50V	100nF
C631	ECUV1H104ZFX	S.M.CAP	50V	100nF
C632	ECUV1H104ZFX	S.M.CAP	50V	100nF
C633	ECUV1H102JCX	S.M.CAP	50V	1nF
C636	ECUV1H101JCX	S.M.CAP	50V	100pF
C637	ECUV1H102KBX	S.M.CAP	50V	1nF
C638	ECUV1H181JCX	S.M.CAP	50V	180pF
C639	ECUV1H561KBX	S.M.CAP	50V	560pF
C701	ECEA1HGE101	ELECT	50V	100µF
C702	ECUV1H103KBX	S.M.CAP	50V	10nF
C703	ECEA1HGE100	ELECT	50V	10µF
C704	ECQB1H223K	FILM	50V	22nF
C705	ECQB1H102J	FILM	50V	1nF
C801	ECUV1H101JCX	S.M.CAP	50V	100pF
C802	ECQE6104K	FILM	600V	100nF
C803	ECUV1H560JX	S.M.CAP	50V	56pF
C804	ECA1HM101GB	ELECT	50V	100pF
C805	ECUV1H104ZFX	S.M.CAP	50V	100nF
C806	ECEA1HU101	ELECT	50V	100µF
C807	ECEA1EGE101	ELECT	25V	100µF
C808	ECQB1H103J	FILM	50V	10nF
C809	ECQB1H103J	FILM	50V	10nF
C810	ECQU2A224MN	FILM	250V	220nF
C811	ECEA1HN010	ELECT	50V	1µF
C815	ECKC2H472J	CERAMIC	500V	4.7nF
C816	ECKC3D222JB	CERAMIC	2KV	2200pF
C817	ECQB1H223K	FILM	50V	22nF
C818	ECKC2H472J	CERAMIC	500V	4.7nF
C820	ECOS2GG181NGELECT		400V	180µF
C821	ECKCNS332J	CERAMIC	1.2KV	3.3nF
C851	ECKC2H681J	CERAMIC	500V	680pF
C852	ECEA1HU102	ELECT	50V	1000µF
C853	ECEA1EGE222	ELECT	25V	2200µF
C854	ECEA1HGE102	ELECT	50V	1000µF
C855	ECKC3D471JB	CERAMIC	2KV	470pF
C856	ECEA1EGE222	ELECT	25V	2200µF
C857	ECEA2EU101	ELECT	250V	100µF
C858	ECUV1H103ZFX	S.M.CAP	50V	10nF
C859	ECUV1H103ZFX	S.M.CAP	50V	10nF
C860	ECA1CM471GB	ELECT	16V	470pF
C861	ECOS2EA221AB	ELECT	250V	220µF
C862	ECA1CM471GB	ELECT	16V	470pF
C901	ECUV1H030CCX	S.M.CAP	50V	30pF
C902	ECA1VM101GB	ELECT	35V	100pF
C903	ECA1CM470GB	ELECT	16V	47µF
C904	ECUV1H103ZFX	S.M.CAP	50V	10nF
C905	ECA1HM4R7GB	ELECT	50V	4.7µF
C906	ECUV1H471KBX	S.M.CAP	50V	470pF
C907	ECUV1H271JCX	S.M.CAP	50V	270pF
C908	ECUV1H151JCX	S.M.CAP	50V	150pF
C909	ECKC2H472J	CERAMIC	500V	4.7nF
C910	ECKC2H472J	CERAMIC	500V	4.7nF
C911	ECUV1H151JCX	S.M.CAP	50V	150pF
C912	ECEA2CU100	ELECT	160V	10µF
C913	ECA1HM101GB	ELECT	50V	100pF
C914	ECA1HM101GB	ELECT	50V	100pF
C915	ECA1CM471GB	ELECT	16V	470pF
C916	ECEA2CU100	ELECT	160V	10µF
C1051	ECA0JM101G	ELECT	6.3V	100pF
C1052	ECUV1H104ZFX	S.M.CAP	50V	100nF
C1201	ECUV1H332KBX	S.M.CAP	50V	3.3nF
C1202	ECUV1H332KBX	S.M.CAP	50V	3.3nF
C1203	ECUV1H332KBX	S.M.CAP	50V	3.3nF
C1204	ECUV1H332KBX	S.M.CAP	50V	3.3nF
C1205	ECUV1H103ZFX	S.M.CAP	50V	10nF
C1206	ECA1HM4R7GB	ELECT	50V	4.7µF

Ref No.	Part No.	Description
C1207	ECUV1H472KBX S.M.CAP	50V 4.7nF
C1208	ECUV1H390JCX S.M.CAP	50V 39pF
C1209	ECUV1H390JCX S.M.CAP	50V 39pF
C1210	ECUV1H103ZFX S.M.CAP	50V 10nF
C1211	ECUV1H470JCX S.M.CAP	50V 47pF
C1212	ECA1CM470GB ELECT	16V 47µF
C1213	ECUV1H103ZFX S.M.CAP	50V 10nF
C1214	ECA1CM470GB ELECT	16V 47µF
C1215	ECUV1H103ZFX S.M.CAP	50V 10nF
C1217	ECUV1H104ZFX S.M.CAP	50V 100nF
C1219	ECA1CM471GB ELECT	16V 470pF
C1220	ECUV1H103ZFX S.M.CAP	50V 10nF
C1221	ECA0JM102GB ELECT	6.3V 1nF
C1222	ECUV1H104ZFX S.M.CAP	50V 100nF
C1223	ECA1HM101GB ELECT	50V 100pF
C1224	ECA0JM222GB ELECT	6.3V 2.2nF
C1225	ECA0JM472GE ELECT	6.3V 4.7nF
C1226	ECA1HM101GB ELECT	50V 100pF
C2101	ECUV1H223KBX S.M.CAP	50V 22nF
C2102	ECUV1H391KBX S.M.CAP	50V 390pF
C2103	ECUV1H102KBX S.M.CAP	50V 1nF
C2104	ECUV1H102KBX S.M.CAP	50V 1nF
C2107	ECUV1H391KBX S.M.CAP	50V 390pF
C2108	ECA1CM101GB ELECT	16V 100pF
C2109	ECUV1H223KBX S.M.CAP	50V 22nF
C2110	ECA1CM100GB ELECT	16V 10pF
C2111	ECUV1H104ZFX S.M.CAP	50V 100nF
C2112	ECA1CM100GB ELECT	16V 10pF
C2113	ECUV1H102KBX S.M.CAP	50V 1nF
C2114	ECUV1H104ZFX S.M.CAP	50V 100nF
C2115	ECUV1H471KBX S.M.CAP	50V 470pF
C2116	ECA1HM3R3GB ELECT	50V 3.3µF
C2117	ECUV1H471KBX S.M.CAP	50V 470pF
C2118	ECUV1H104ZFX S.M.CAP	50V 100nF
C2119	ECA1CM100GB ELECT	16V 10pF
C2120	ECUV1H104ZFX S.M.CAP	50V 100nF
C2121	ECUV1H104ZFX S.M.CAP	50V 100nF
C2122	ECUV1H104ZFX S.M.CAP	50V 100nF
C2123	ECA1CM100GB ELECT	16V 10pF
C2124	ECUV1H104ZFX S.M.CAP	50V 100nF
C2125	ECUV1H030CCX S.M.CAP	50V 30pF
C2126	ECUV1H030CCX S.M.CAP	50V 30pF
C2127	ECA1CM100GB ELECT	16V 10pF
C2307	ECA1CM470GB ELECT	16V 47µF
C2308	ECA1CM470GB ELECT	16V 47µF
C2309	ECA1CM101GB ELECT	16V 100pF
C2310	ECA1CM470GB ELECT	16V 47µF
C2312	ECUV1H104ZFX S.M.CAP	50V 100nF
C2313	ECUV1H103KBX S.M.CAP	50V 10nF
C2314	ECUV1H104ZFX S.M.CAP	50V 100nF
C2315	ECUV1H103KBX S.M.CAP	50V 10nF
C2316	ECUV1H103ZFX S.M.CAP	50V 10nF
C2317	ECA1CM470GB ELECT	16V 47µF
C2318	ECUV1H222KBX S.M.CAP	50V 2.2nF
C2319	ECUV1H222KBX S.M.CAP	50V 2.2nF
C2651	ECUV1H103KBX S.M.CAP	50V 10nF
C2652	ECUV1H103KBX S.M.CAP	50V 10nF
C3001	ECA1HMR47GB ELECT	50V 0.47µF
C3002	ECA1HMR47GB ELECT	50V 0.47µF
C3003	ECA1EM4R7GB ELECT	25V 4.7µF
C3004	ECA1HM4R7GB ELECT	50V 4.7µF
C3005	ECA1HM4R7GB ELECT	50V 4.7µF
C3006	ECUV1H473ZFX S.M.CAP	50V 47nF
C3007	ECA1HM470GB ELECT	50V 47µF
C3011	ECUV1H473ZFX S.M.CAP	50V 47nF
C3012	ECA1CM470GB ELECT	16V 47µF
C3013	ECUV1H104ZFX S.M.CAP	50V 100nF
C3014	ECUV1H104ZFX S.M.CAP	50V 100nF
C3017	ECEA1CN470 ELECT	16V 47µF
C3018	ECUV1H102KBX S.M.CAP	50V 1nF
C3019	ECUV1H102KBX S.M.CAP	50V 1nF
C3020	ECCF1H070DC CERAMIC	50V 7pF

Ref No.	Part No.	Description
C3021	ECUV1H102KBX S.M.CAP	50V 1nF
C3023	ECA1CM470GB ELECT	16V 47µF
C3024	ECUV1H473ZFX S.M.CAP	50V 47nF
C3025	ECUV1H102KBX S.M.CAP	50V 1nF
C3026	ECA1CM470GB ELECT	16V 47µF
C3027	ECA1CM470GB ELECT	16V 47µF
C3028	ECUV1H221JX S.M.CAP	50V 220pF
C3029	ECUV1H221JX S.M.CAP	50V 220pF
C3030	ECUV1H221JX S.M.CAP	50V 220pF
C3031	ECUV1H221JX S.M.CAP	50V 220pF
C3032	ECA1HMR47GB ELECT	50V 0.47µF
C3033	ECA1HMR47GB ELECT	50V 0.47µF
C3034	ECUV1H221JX S.M.CAP	50V 220pF
C3035	ECUV1H221JX S.M.CAP	50V 220pF
C3036	ECUV1H222KBX S.M.CAP	50V 2.2nF
C3037	ECUV1H561JCX S.M.CAP	50V 560pF
C3038	ECA1CM470GB ELECT	16V 47µF
C3039	ECA1CM470GB ELECT	16V 47µF
C3040	ECA1HMR47GB ELECT	50V 0.47µF
C3041	ECA1HMR47GB ELECT	50V 0.47µF
C3043	ECA1HM4R7GB ELECT	50V 4.7µF
C3045	ECUV1H104ZFX S.M.CAP	50V 100nF
C3050	ECUV1H222KBX S.M.CAP	50V 2.2nF
C3051	ECUV1H222KBX S.M.CAP	50V 2.2nF
C3052	ECUV1H561JCX S.M.CAP	50V 560pF
C3053	ECUV1H561JCX S.M.CAP	50V 560pF
C3054	ECUV1H222KBX S.M.CAP	50V 2.2nF
C3055	ECUV1H561JCX S.M.CAP	50V 560pF
C3056	ECUV1H101JCX S.M.CAP	50V 100pF
C3062	ECUV1H104ZFX S.M.CAP	50V 100nF
C3071	ECUV1H104ZFX S.M.CAP	50V 100nF
C3151	ECUV1H561JCX S.M.CAP	50V 560pF
C3152	ECUV1H561JCX S.M.CAP	50V 560pF
C3501	ECUV1H104ZFX S.M.CAP	50V 100nF
C3502	ECA1HM101GB ELECT	50V 100pF
C3503	ECUV1H103ZFX S.M.CAP	50V 10nF
C3504	ECUV1H102JCX S.M.CAP	50V 1nF
C3505	ECUV1H104ZFX S.M.CAP	50V 100nF
C3506	ECA1CM470GB ELECT	16V 47µF
C3507	ECA1CM470GB ELECT	16V 47µF
C3508	ECUV1H473ZFX S.M.CAP	50V 47nF
C3509	ECUV1H103ZFX S.M.CAP	50V 10nF
C3510	ECA0JM102GB ELECT	6.3V 1nF
C3511	ECUV1H103ZFX S.M.CAP	50V 10nF

**DIODES**

D251	MA2180TP	DIODE
D252	MA165TA5	DIODE
D253	MA700TA5	DIODE
D254	MA700TA5	DIODE
D310	MA165TA5	DIODE
D311	MA29TA5	DIODE
D312	MA29TA5	DIODE
D354	ERA22-04V1	DIODE
D355	ERA22-04V1	DIODE
D356	ERA22-04V1	DIODE
D357	MA165TA5	DIODE
D358	MA165TA5	DIODE
D359	MA165TA5	DIODE
D360	MA4150	DIODE
D451	MA165TA5	DIODE
D452	MA165TA5	DIODE
D454	ERA15-02V3	DIODE
D456	MA2160BLFS	DIODE
D501	MA165TA5	DIODE
D502	EU02	DIODE
D551	ERD07-15L7	DIODE
D552	TVSRU2AM	DIODE
D554	AU02V0	DIODE
D556	MA166TA5	DIODE

Ref No.	Part No.	Description
D601	MA165TA5	DIODE
D602	MA165TA5	DIODE
D604	MA165TA5	DIODE
D605	MA165TA5	DIODE
D606	MA165TA5	DIODE
D609	MA167TA5	DIODE
D701	MA165TA5	DIODE
D702	MA4056	DIODE
D801	MA165TA5	DIODE
D802	MA165TA5	DIODE
D803	MA165TA5	DIODE
D804	ERA15-02V3	DIODE
D805	EU02	DIODE
D806	RBV4-08	DIODE
D807	EU02	DIODE
D808	PC120FY	DIODE
D809	MA165TA5	DIODE
D851	EU02	DIODE
D852	ERD32-02L7	DIODE
D853	FML22SLF610	DIODE
D854	RU4AMLf-M1	DIODE
D855	RU4BLf-L1	DIODE
D856	MA4047	DIODE
D857	MA4300	DIODE
D858	MA29TA5	DIODE
D901	MA165TA5	DIODE
D902	MA165TA5	DIODE
D904	MA165TA5	DIODE
D906	RLS72TE-11	DIODE
D1201	LN81RPHL	DIODE
D1203	MA4082	DIODE
D1204	TVSS1WBS20	DIODE
D1205	MA165TA5	DIODE
D1207	MA165TA5	DIODE
D1208	MA165TA5	DIODE
D1209	MA165TA5	DIODE
D2303	MA165TA5	DIODE
D2304	MA4091	DIODE
D3001	MA4120	DIODE
D3003	MA4082	DIODE
D3004	MA4100	DIODE
D3005	MA4120	DIODE
D3006	MA4120	DIODE
D3007	MA4120	DIODE
D3008	MA4082	DIODE
D3009	MA4082	DIODE
D3010	MA4082	DIODE
D3011	MA4082	DIODE
D3012	MA4120	DIODE
D3013	MA4120	DIODE
D3014	MA4120	DIODE
D3015	MA4120	DIODE
D3016	MA4120	DIODE
D3018	MA165TA5	DIODE
D3019	MA165TA5	DIODE
D3501	MA165TA5	DIODE

### FUSES

F801	19181-3.15	FUSE	▲
F851	TR5-T1250	FUSE	▲
F852	TR5-T2000	FUSE	▲
F853	TR5-T2000	FUSE	▲
F8011	EYF52BC	FUSE HOLDER	
F8012	EYF52BC	FUSE HOLDER	

### SOCKETS

H1202	832AG11D-ESL	I.C.SOCKET
-------	--------------	------------

Ref No.	Part No.	Description
<b>TERMINALS AND LINKS</b>		
JA.1	ERJ6GEY0R00	S.M.CARB 0.1W 5% 0Ω
JA.1	ERJ8GEY0R00	S.M.CAR .125W 5% 0Ω
JA.10	ERJ6GEY0R00	S.M.CARB 0.1W 5% 0Ω
JA.11	ERJ8GEY0R00	S.M.CAR .125W 5% 0Ω
JA.12	ERJ8GEY0R00	S.M.CAR .125W 5% 0Ω
JA.13	ERJ6GEY0R00	S.M.CARB 0.1W 5% 0Ω
JA.14	ERJ8GEY0R00	S.M.CAR .125W 5% 0Ω
JA.15	ERJ8GEY0R00	S.M.CAR .125W 5% 0Ω
JA.16	ERJ8GEY0R00	S.M.CAR .125W 5% 0Ω
JA.17	ERJ8GEY0R00	S.M.CAR .125W 5% 0Ω
JA.18	ERJ6GEY0R00	S.M.CARB 0.1W 5% 0Ω
JA.19	ERJ6GEY0R00	S.M.CARB 0.1W 5% 0Ω
JA.2	ERJ6GEY0R00	S.M.CARB 0.1W 5% 0Ω
JA.2	ERJ8GEY0R00	S.M.CAR .125W 5% 0Ω
JA.20	ERJ6GEY0R00	S.M.CARB 0.1W 5% 0Ω
JA.21	ERJ6GEY0R00	S.M.CARB 0.1W 5% 0Ω
JA.22	ERJ8GEY0R00	S.M.CAR .125W 5% 0Ω
JA.24	ERJ6GEY0R00	S.M.CARB 0.1W 5% 0Ω
JA.25	ERJ8GEY0R00	S.M.CAR .125W 5% 0Ω
JA.26	ERJ6GEY0R00	S.M.CARB 0.1W 5% 0Ω
JA.27	ERJ6GEY0R00	S.M.CARB 0.1W 5% 0Ω
JA.28	ERJ6GEY0R00	S.M.CARB 0.1W 5% 0Ω
JA.29	ERJ6GEY0R00	S.M.CARB 0.1W 5% 0Ω
JA.3	ERJ8GEY0R00	S.M.CAR .125W 5% 0Ω
JA.30	ERJ6GEY0R00	S.M.CARB 0.1W 5% 0Ω
JA.34	ERJ6GEY0R00	S.M.CARB 0.1W 5% 0Ω
JA.35	ERJ6GEY0R00	S.M.CARB 0.1W 5% 0Ω
JA.36	ERJ6GEY0R00	S.M.CARB 0.1W 5% 0Ω
JA.37	ERJ6GEY0R00	S.M.CARB 0.1W 5% 0Ω
JA.38	ERJ6GEY0R00	S.M.CARB 0.1W 5% 0Ω
JA.4	ERJ8GEY0R00	S.M.CAR .125W 5% 0Ω
JA.5	ERJ6GEY0R00	S.M.CARB 0.1W 5% 0Ω
JA.6	ERJ8GEY0R00	S.M.CAR .125W 5% 0Ω
JA.7	ERJ8GEY0R00	S.M.CAR .125W 5% 0Ω
JA.8	ERJ6GEY0R00	S.M.CARB 0.1W 5% 0Ω
JA.9	ERJ6GEY0R00	S.M.CARB 0.1W 5% 0Ω
JA1	ERJ6GEY0R00	S.M.CARB 0.1W 5% 0Ω
JA10	ERJ6GEY0R00	S.M.CARB 0.1W 5% 0Ω
JA11	ERJ6GEY0R00	S.M.CARB 0.1W 5% 0Ω
JA12	ERJ6GEY0R00	S.M.CARB 0.1W 5% 0Ω
JA13	ERJ6GEY0R00	S.M.CARB 0.1W 5% 0Ω
JA14	ERJ6GEY0R00	S.M.CARB 0.1W 5% 0Ω
JA15	ERJ6GEY0R00	S.M.CARB 0.1W 5% 0Ω
JA16	ERJ6GEY0R00	S.M.CARB 0.1W 5% 0Ω
JA17	ERJ6GEY0R00	S.M.CARB 0.1W 5% 0Ω
JA18	ERJ6GEY0R00	S.M.CARB 0.1W 5% 0Ω
JA19	ERJ6GEY0R00	S.M.CARB 0.1W 5% 0Ω
JA2	ERJ6GEY0R00	S.M.CARB 0.1W 5% 0Ω
JA20	ERJ6GEY0R00	S.M.CARB 0.1W 5% 0Ω
JA21	ERJ6GEY0R00	S.M.CARB 0.1W 5% 0Ω
JA22	ERJ6GEY0R00	S.M.CARB 0.1W 5% 0Ω
JA23	ERJ6GEY0R00	S.M.CARB 0.1W 5% 0Ω
JA24	ERJ6GEY0R00	S.M.CARB 0.1W 5% 0Ω
JA25	ERJ6GEY0R00	S.M.CARB 0.1W 5% 0Ω
JA26	ERJ6GEY0R00	S.M.CARB 0.1W 5% 0Ω
JA28	ERJ6GEY0R00	S.M.CARB 0.1W 5% 0Ω
JA29	ERJ6GEY0R00	S.M.CARB 0.1W 5% 0Ω
JA3	ERJ6GEY0R00	S.M.CARB 0.1W 5% 0Ω
JA30	ERJ6GEY0R00	S.M.CARB 0.1W 5% 0Ω
JA31	ERJ6GEY0R00	S.M.CARB 0.1W 5% 0Ω
JA32	ERJ6GEY0R00	S.M.CARB 0.1W 5% 0Ω
JA33	ERJ6GEY0R00	S.M.CARB 0.1W 5% 0Ω
JA4	ERJ6GEY0R00	S.M.CARB 0.1W 5% 0Ω
JA5	ERJ6GEY0R00	S.M.CARB 0.1W 5% 0Ω
JA6	ERJ6GEY0R00	S.M.CARB 0.1W 5% 0Ω
JA7	ERJ6GEY0R00	S.M.CARB 0.1W 5% 0Ω
JA8	ERJ6GEY0R00	S.M.CARB 0.1W 5% 0Ω
JA9	ERJ6GEY0R00	S.M.CARB 0.1W 5% 0Ω
JK2301	TJB18644	AV TERMINAL
JK3001	TJS8E007	21PIN TERMINAL

Ref No.	Part No.	Description
JK3101	TJS8E007	21PIN TERMINAL
JK3102	TJB16673	AV TERMINAL
JSB.5	ERJ6GEY0R00	S.M.CARB 0.1W 5% 0Ω
JS E011	ERJ6GEY0R00	S.M.CARB 0.1W 5% 0Ω
JS E012	ERJ6GEY0R00	S.M.CARB 0.1W 5% 0Ω
JS E013	ERJ6GEY0R00	S.M.CARB 0.1W 5% 0Ω
JS E014	ERJ6GEY0R00	S.M.CARB 0.1W 5% 0Ω
JS E015	ERJ6GEY0R00	S.M.CARB 0.1W 5% 0Ω
JS E016	ERJ6GEY0R00	S.M.CARB 0.1W 5% 0Ω
JS E031	ERJ6GEY0R00	S.M.CARB 0.1W 5% 0Ω
JS E032	ERJ6GEY0R00	S.M.CARB 0.1W 5% 0Ω
JS E036	ERJ6GEY0R00	S.M.CARB 0.1W 5% 0Ω
JS E038	ERJ6GEY0R00	S.M.CARB 0.1W 5% 0Ω

## COILS

L001	TLT100K991R	COIL
L002	TLT047K991R	COIL
L102	EIV7EN200B	COIL
L103	TLT100K991R	COIL
L104	EIV7EN201B	COIL
L105	TLT100K991R	COIL
L106	TLT022K991R	COIL
L109	TLTR47K991R	COIL
L111	ELESNR82MA	COIL
L112	EXCELSA35T	COIL
L113	EXCELSA35T	COIL
L202	TLT068K991R	COIL
L251	EXCELSA35T	COIL
L301	TLT047K991R	COIL
L302	EXCEMT101BT	COIL
L303	EXCEMT101BT	COIL
L304	EXCEMT101BT	COIL
L352	SDL-4101	COIL
L353	SDL-4101	COIL
L354	SDL-4101	COIL
L552	ELH5L429	COIL
L553	ELC08D055	COIL
L554	297-23293	COIL
L601	TLT047K991R	COIL
L602	EXCELDR35V	COIL
L603	TLT047K991R	COIL
L604	EXCELDR35V	COIL
L606	TLT015K991R	COIL
L607	EXCELSA35T	COIL
L701	ELC10D006	COIL
L801	EXCELSA24T	COIL
L802	TLT022K991R	COIL
L803	ELF18D490F	COIL
L804	ELESN4R7KA	COIL
L805	298-82858001	COIL
L851	EXCELDR35V	COIL
L852	EXCELSA35T	COIL
L853	ELEIE470KA	COIL
L854	ELEIN470KA	COIL
L855	ELEIN470KA	COIL
L856	ELEIN470KA	COIL
L901	EXCELSA24T	COIL
L902	EXCELSA24T	COIL
L1051	TLT331K991R	COIL
L1201	TLT047K991R	COIL
L1202	TLT047K991R	COIL
L1203	TLT047K991R	COIL
L1204	EXCELDR35V	COIL
L2101	TLT100K991R	COIL
L2102	TLT3R9K991R	COIL
L2103	EXCELSA35T	COIL
L2104	EXCELSA35T	COIL
L3151	EXCEMT101BT	COIL
L3152	EXCEMT101BT	COIL
L3153	EXCEMT101BT	COIL

Ref No.	Part No.	Description
L3154	EXCEMT101BT	COIL
L3155	ELEBT6R8KA	COIL
L3156	ELEBT6R8KA	COIL
L3158	EXCELSA39V	COIL
L3501	EXCELDR35V	COIL
L3502	EXCELDR35V	COIL
L3503	ELESN4R7KA	COIL
L3504	EXCELSA35T	COIL

## TRANSISTORS

Q101	BF370-126	TRANSISTOR
Q102	BF370-126	TRANSISTOR
Q103	BC847B	TRANSISTOR
Q201	BC847B	TRANSISTOR
Q202	BC847B	TRANSISTOR
Q251	2SD1328STX	TRANSISTOR
Q252	2SD1328STX	TRANSISTOR
Q253	BC847B	TRANSISTOR
Q301	BC857B	TRANSISTOR
Q302	BC847B	TRANSISTOR
Q303	BC857B	TRANSISTOR
Q304	BC847B	TRANSISTOR
Q305	BC857B	TRANSISTOR
Q306	BC847B	TRANSISTOR
Q307	BC847B	TRANSISTOR
Q308	BC847B	TRANSISTOR
Q309	BC847B	TRANSISTOR
Q310	BC847B	TRANSISTOR
Q311	BC847B	TRANSISTOR
Q351	2SA1767	TRANSISTOR
Q352	2SA1767	TRANSISTOR
Q353	2SA1767	TRANSISTOR
Q451	BC847B	TRANSISTOR
Q501	BC847B	TRANSISTOR
Q502	BC847B	TRANSISTOR
Q503	2SD836-AL	TRANSISTOR
Q504	BC847B	TRANSISTOR
Q551	2SD1577LB	TRANSISTOR
Q552	2SC1473-RN	TRANSISTOR
Q701	BC857B	TRANSISTOR
Q801	2SC1573	TRANSISTOR
Q802	S2000NLBMA	TRANSISTOR
Q851	2SD1273PLB	TRANSISTOR
Q852	TFD312SOF632	DIODE
Q901	BC847B	TRANSISTOR
Q902	BC847B	TRANSISTOR
Q903	BC847B	TRANSISTOR
Q904	BC857B	TRANSISTOR
Q905	BC847B	TRANSISTOR
Q906	BC847B	TRANSISTOR
Q907	BC857B	TRANSISTOR
Q908	2SB940APLB	TRANSISTOR
Q909	2SD1264APLB	TRANSISTOR
Q1201	BC847B	TRANSISTOR
Q1202	BC847B	TRANSISTOR
Q1205	BC847B	TRANSISTOR
Q1206	BC847B	TRANSISTOR
Q1207	BC847B	TRANSISTOR
Q1208	BC857B	TRANSISTOR
Q2101	BC860B	TRANSISTOR
Q2102	BC860B	TRANSISTOR
Q2301	BC857B	TRANSISTOR
Q2302	BC857B	TRANSISTOR
Q2305	2SD1328STX	TRANSISTOR
Q2306	2SD1328STX	TRANSISTOR
Q2307	BC860B	TRANSISTOR
Q2308	BC857B	TRANSISTOR
Q2309	BC860B	TRANSISTOR
Q2310	BC860B	TRANSISTOR
Q3001	2SC1318-S	TRANSISTOR

Ref No.	Part No.	Description
Q3004	BC847B	TRANSISTOR
Q3005	BC847B	TRANSISTOR
Q3006	2SC1318—S	TRANSISTOR
Q3011	BC857B	TRANSISTOR
Q3012	2SD1328STX	TRANSISTOR
Q3013	2SD1328STX	TRANSISTOR
<b>RESISTOR</b>		
R.604	ERJ6GEY0R00	S.M.CARB 0.1W 5% 0Ω
R.622	ERJ6GEY0R00	S.M.CARB 0.1W 5% 0Ω
R.925	ERJ6GEY0R00	S.M.CARB 0.1W 5% 0Ω
R.926	ERJ6GEY0R00	S.M.CARB 0.1W 5% 0Ω
R001	ERJ6GEYJ223	S.M.CARB 0.1W 5% 22KΩ
R002	ERJ6GEYJ101	S.M.CARB 0.1W 5% 100Ω
R003	ERJ6GEYJ101	S.M.CARB 0.1W 5% 100Ω
R004	ERJ6GEYJ101	S.M.CARB 0.1W 5% 100Ω
R107	ERJ6GEY0R00	S.M.CARB 0.1W 5% 0Ω
R109	ERJ6GEY0R00	S.M.CARB 0.1W 5% 0Ω
R113	ERJ6GEYJ153	S.M.CARB 0.1W 5% 15KΩ
R116	ERJ6GEYJ103	S.M.CARB 0.1W 5% 10KΩ
R117	ERJ6GEYJ683	S.M.CARB 0.1W 5% 68KΩ
R118	ERJ6ENF4701	S.M.CARB 0.1W 1% 4K7Ω
R119	ERJ6ENF1202	S.M.CARB 0.1W 1% 1K2Ω
R120	ERJ6GEYJ102	S.M.CARB 0.1W 5% 1KΩ
R121	ERJ6GEYJ201	S.M.CARB 0.1W 5% 200Ω
R122	ERJ6GEYJ470	S.M.CARB 0.1W 5% 47Ω
R123	ERJ6GEY0R00	S.M.CARB 0.1W 5% 0Ω
R124	ERJ6GEYJ682	S.M.CARB 0.1W 5% 6K8Ω
R125	ERJ6GEYJ102	S.M.CARB 0.1W 5% 1KΩ
R126	EVNDXAA03B53	CONTROL 5KΩ
R127	ERDS1TJ121	CARBON 0.5W 5% 120Ω
R128	ERJ6GEYJ271	S.M.CARB 0.1W 5% 270Ω
R129	ERJ6GEYJ332	S.M.CARB 0.1W 5% 3K3Ω
R130	ERJ6GEYJ101	S.M.CARB 0.1W 5% 100Ω
R131	ERJ6GEYJ102	S.M.CARB 0.1W 5% 1KΩ
R132	ERJ6GEYJ222	S.M.CARB 0.1W 5% 2K2Ω
R133	ERJ6GEYJ682	S.M.CARB 0.1W 5% 6K8Ω
R134	ERJ6GEYJ222	S.M.CARB 0.1W 5% 2K2Ω
R136	ERJ6GEYJ473	S.M.CARB 0.1W 5% 47KΩ
R137	ERJ6GEYJ563	S.M.CARB 0.1W 5% 56KΩ
R138	ERJ6GEYJ101	S.M.CARB 0.1W 5% 100Ω
R139	ERJ6GEY0R00	S.M.CARB 0.1W 5% 0Ω
R141	ERJ6GEYJ102	S.M.CARB 0.1W 5% 1KΩ
R142	ERJ6GEY0R00	S.M.CARB 0.1W 5% 0Ω
R143	ERJ6GEY0R00	S.M.CARB 0.1W 5% 0Ω
R145	ERJ6GEYJ152	S.M.CARB 0.1W 5% 1K5Ω
R146	ERJ6GEYJ471	S.M.CARB 0.1W 5% 470Ω
R147	ERJ6GEYJ821	S.M.CARB 0.1W 5% 820Ω
R149	ERJ6GEYJ181	S.M.CARB 0.1W 5% 180Ω
R201	ERJ6GEYJ471	S.M.CARB 0.1W 5% 470Ω
R203	ERJ6GEY0R00	S.M.CARB 0.1W 5% 0Ω
R204	ERJ6GEYJ471	S.M.CARB 0.1W 5% 470Ω
R205	ERJ6GEYJ332	S.M.CARB 0.1W 5% 3K3Ω
R206	ERJ6GEYJ681	S.M.CARB 0.1W 5% 680Ω
R207	ERJ6GEYJ103	S.M.CARB 0.1W 5% 10KΩ
R208	ERJ6GEYJ222	S.M.CARB 0.1W 5% 2K2Ω
R209	ERJ6GEYJ332	S.M.CARB 0.1W 5% 3K3Ω
R210	ERJ6GEYJ471	S.M.CARB 0.1W 5% 470Ω
R251	ERJ6GEYJ101	S.M.CARB 0.1W 5% 100Ω
R252	ERJ6GEYJ272	S.M.CARB 0.1W 5% 2K7Ω
R253	ERJ6GEYJ103	S.M.CARB 0.1W 5% 10KΩ
R254	ERJ6GEYJ101	S.M.CARB 0.1W 5% 100Ω
R255	ERJ6GEYJ103	S.M.CARB 0.1W 5% 10KΩ
R256	ERJ6GEYJ471	S.M.CARB 0.1W 5% 470Ω
R257	ERJ6GEYJ330	S.M.CARB 0.1W 5% 33Ω
R258	ERJ6GEYJ272	S.M.CARB 0.1W 5% 2K7Ω
R259	ERJ6GEYJ330	S.M.CARB 0.1W 5% 33Ω
R260	ERJ6GEYJ103	S.M.CARB 0.1W 5% 10KΩ
R261	ERJ6GEYJ471	S.M.CARB 0.1W 5% 470Ω
R262	ERJ6GEYJ103	S.M.CARB 0.1W 5% 10KΩ

Ref No.	Part No.	Description
R263	ERJ6GEYJ104	S.M.CARB 0.1W 5% 100KΩ
R264	ERJ6GEYJ473	S.M.CARB 0.1W 5% 47KΩ
R265	ERD25TJ2R2	CARBON 0.25W 5% 2R2Ω
R266	ERD25TJ2R2	CARBON 0.25W 5% 2R2Ω
R267	ERF7ZK4R7	WOUND 7W 10% 4R7Ω ▲
R268	ERJ6GEYJ103	S.M.CARB 0.1W 5% 10KΩ
R269	ERJ6GEYJ273	S.M.CARB 0.1W 5% 27KΩ
R271	ERJ6GEYJ103	S.M.CARB 0.1W 5% 10KΩ
R272	ERF7ZK5R6	WOUND 7W 10% 5R6Ω ▲
R273	ERD25TJ273	CARBON 0.25W 5% 27KΩ
R301	ERJ6GEYJ750	S.M.CARB 0.1W 5% 75Ω
R302	ERJ6GEYJ471	S.M.CARB 0.1W 5% 470Ω
R303	ERJ6GEYJ471	S.M.CARB 0.1W 5% 470Ω
R304	ERJ6GEYJ471	S.M.CARB 0.1W 5% 470Ω
R305	ERJ6GEYJ750	S.M.CARB 0.1W 5% 75Ω
R306	ERJ6GEYJ471	S.M.CARB 0.1W 5% 470Ω
R307	ERJ6GEYJ471	S.M.CARB 0.1W 5% 470Ω
R308	ERJ6GEYJ471	S.M.CARB 0.1W 5% 470Ω
R309	ERJ6GEYJ750	S.M.CARB 0.1W 5% 75Ω
R310	ERJ6GEYJ471	S.M.CARB 0.1W 5% 470Ω
R311	ERJ6GEYJ471	S.M.CARB 0.1W 5% 470Ω
R312	ERJ6GEYJ471	S.M.CARB 0.1W 5% 470Ω
R313	ERJ6GEYJ101	S.M.CARB 0.1W 5% 100Ω
R314	ERJ6GEYJ332	S.M.CARB 0.1W 5% 3K3Ω
R315	ERJ6GEYJ332	S.M.CARB 0.1W 5% 3K3Ω
R316	ERJ6GEYJ332	S.M.CARB 0.1W 5% 3K3Ω
R321	ERJ6GEYJ473	S.M.CARB 0.1W 5% 47KΩ
R322	ERJ6GEYJ473	S.M.CARB 0.1W 5% 47KΩ
R323	ERJ6GEYJ103	S.M.CARB 0.1W 5% 10KΩ
R324	ERJ6GEYJ104	S.M.CARB 0.1W 5% 100KΩ
R351	ERJ6GEYJ102	S.M.CARB 0.1W 5% 1KΩ
R352	ERJ6GEYJ102	S.M.CARB 0.1W 5% 1KΩ
R353	ERJ6GEYJ102	S.M.CARB 0.1W 5% 1KΩ
R354	ERJ6GEYJ102	S.M.CARB 0.1W 5% 1KΩ
R355	ERJ6GEYJ102	S.M.CARB 0.1W 5% 1KΩ
R356	ERJ6GEYJ102	S.M.CARB 0.1W 5% 1KΩ
R357	ERG1SJ683	METAL 1W 5% 680Ω
R358	ERG1SJ683	METAL 1W 5% 680Ω
R359	ERG1SJ683	METAL 1W 5% 680Ω
R363	ERD25TJ103	CARBON 0.25W 5% 10KΩ
R364	ERD25TJ103	CARBON 0.25W 5% 10KΩ
R365	ERD25TJ103	CARBON 0.25W 5% 10KΩ
R366	ERDS1TJ152	CARBON 0.5W 5% 1K5Ω
R367	ERDS1TJ152	CARBON 0.5W 5% 1K5Ω
R368	ERDS1TJ152	CARBON 0.5W 5% 1K5Ω
R369	ERD25TJ203	CARBON 0.25W 5% 20KΩ
R370	ERJ6GEYJ822	S.M.CARB 0.1W 5% 8K2Ω
R372	ERQ12AJ121	FUSIBLE 0.5W 5% 120Ω ▲
R373	ERJ6GEYJ220	S.M.CARB 0.1W 5% 22Ω
R374	ERD25TJ274	CARBON 0.25W 5% 270KΩ
R375	ERJ6GEYJ684	S.M.CARB 0.1W 5% 680KΩ
R376	ERJ6GEYJ183	S.M.CARB 0.1W 5% 18KΩ
R377	ERQ12HKR82	FUSIBLE 0.5W 10% R82Ω ▲
R381	ERJ6GEYJ102	S.M.CARB 0.1W 5% 1KΩ
R382	ERJ6GEYJ102	S.M.CARB 0.1W 5% 1KΩ
R383	ERJ6GEYJ102	S.M.CARB 0.1W 5% 1KΩ
R451	ERJ6GEYJ223	S.M.CARB 0.1W 5% 22KΩ
R452	ERJ6GEYJ472	S.M.CARB 0.1W 5% 4K7Ω
R453	ERJ6GEYJ104	S.M.CARB 0.1W 5% 100KΩ
R455	ERJ6GEYJ472	S.M.CARB 0.1W 5% 4K7Ω
R456	ERJ6GEYJ103	S.M.CARB 0.1W 5% 10KΩ
R457	ERJ6GEYJ682	S.M.CARB 0.1W 5% 6K8Ω
R458	ERD25TJ1R5	CARBON 0.25W 5% 1R5Ω
R459	ERJ6GEYJ470	S.M.CARB 0.1W 5% 47Ω
R460	ERJ6GEYJ183	S.M.CARB 0.1W 5% 18KΩ
R461	ERDS1TJ471	CARBON 0.5W 5% 470Ω
R462	ERJ6GEYJ472	S.M.CARB 0.1W 5% 4K7Ω
R463	ERJ6GEYJ472	S.M.CARB 0.1W 5% 4K7Ω
R464	ERW12PKR68	WIREWOUND 0.5W 10% R68Ω ▲
R465	ERJ6GEYJ101	S.M.CARB 0.1W 5% 100Ω
R466	ERO25CKF1801	METAL 0.25W 1% 1K8Ω ▲
R467	ERO25CKF1801	METAL 0.25W 1% 1K8Ω ▲

Ref No.	Part No.	Description				
R471	ERDS1TJ152	CARBON	0.5W	5%	1K5Ω	
R472	ERDS1TJ4R7	CARBON	0.5W	5%	4R7Ω	
R501	ERJ6GEYJ331	S.M.CARB	0.1W	5%	330Ω	
R502	ERJ6GEYJ560	S.M.CARB	0.1W	5%	56Ω	
R503	ERJ6GEYJ273	S.M.CARB	0.1W	5%	27KΩ	
R504	ERJ6GEYJ101	S.M.CARB	0.1W	5%	100Ω	
R506	ERD25TJ560	CARBON	0.25W	5%	56Ω	
R507	ERQ14AJ3R3	METAL	0.25W	5%	3R3Ω	▲
R509	ERDS1TJ152	CARBON	0.5W	5%	1K5Ω	
R510	ERDS1TJ152	CARBON	0.5W	5%	1K5Ω	
R511	ERJ6GEYJ104	S.M.CARB	0.1W	5%	100KΩ	
R512	ERJ6GEYJ472	S.M.CARB	0.1W	5%	4K7Ω	
R513	ERJ6GEYJ123	S.M.CARB	0.1W	5%	12KΩ	
R514	ERJ6GEYJ123	S.M.CARB	0.1W	5%	12KΩ	
R551	ERW2PKR47	WIREWOUND2W		10%0R47Ω		▲
R553	ERG1SJ152	METAL	1W	5%	1K5Ω	
R554	ERQ14AJW101	METAL	0.25W	5%	100Ω	▲
R558	ERDS1TJ124	CARBON	0.5W	5%	120KΩ	
R561	ERJ6GEYJ563	S.M.CARB	0.1W	5%	56KΩ	
R562	ERJ6GEYJ155	S.M.CARB	0.1W	5%	1M5Ω	
R563	ERJ6GEYJ155	S.M.CARB	0.1W	5%	1M5Ω	
R564	ERJ6GEYJ104	S.M.CARB	0.1W	5%	100KΩ	
R566	ERJ6GEYJ273	S.M.CARB	0.1W	5%	27KΩ	
R567	ERJ6GEYJ274	S.M.CARB	0.1W	5%	270KΩ	
R601	ERJ6GEYJ151	S.M.CARB	0.1W	5%	150Ω	
R602	ERJ6GEYJ151	S.M.CARB	0.1W	5%	150Ω	
R603	ERJ6GEYJ750	S.M.CARB	0.1W	5%	75Ω	
R605	ERJ6GEYJ183	S.M.CARB	0.1W	5%	18KΩ	
R606	ERJ6GEYJ472	S.M.CARB	0.1W	5%	4K7Ω	
R607	ERJ6GEYJ103	S.M.CARB	0.1W	5%	10KΩ	
R608	ERJ6GEYJ101	S.M.CARB	0.1W	5%	100Ω	
R609	ERJ6GEYJ101	S.M.CARB	0.1W	5%	100Ω	
R610	ERJ6GEYJ473	S.M.CARB	0.1W	5%	47KΩ	
R611	ERJ6GEYJ102	S.M.CARB	0.1W	5%	1KΩ	
R612	ERJ6GEYJ123	S.M.CARB	0.1W	5%	12KΩ	
R613	ERJ6GEYJ271	S.M.CARB	0.1W	5%	270Ω	
R614	ERJ6GEYJ470	S.M.CARB	0.1W	5%	47Ω	
R615	ERJ6GEYJ333	S.M.CARB	0.1W	5%	33KΩ	
R616	ERJ6GEYJ153	S.M.CARB	0.1W	5%	15KΩ	
R618	ERJ6GEYJ151	S.M.CARB	0.1W	5%	150Ω	
R619	ERJ6GEYJ472	S.M.CARB	0.1W	5%	4K7Ω	
R623	ERJ6GEYJ821	S.M.CARB	0.1W	5%	820Ω	
R701	ERQ12AJ101	FUSIBLE	0.5W	5%	100Ω	▲
R702	ERQ12HJ220	METAL	0.5W	5%	22Ω	▲
R703	ERG2FJ821	METAL	2W	5%	820Ω	▲
R704	ERJ6GEYJ563	S.M.CARB	0.1W	5%	56KΩ	
R705	ERJ6GEYJ104	S.M.CARB	0.1W	5%	100KΩ	
R706	ERJ6GEYJ222	S.M.CARB	0.1W	5%	2K2Ω	
R707	ERJ6GEYJ911	S.M.CARB	0.1W	5%	910Ω	
R708	ERJ6GEYJ393	S.M.CARB	0.1W	5%	39KΩ	
R709	ERJ6GEYJ393	S.M.CARB	0.1W	5%	39KΩ	
R710	ERJ6GEYJ273	S.M.CARB	0.1W	5%	27KΩ	
R711	ERJ6GEYJ681	S.M.CARB	0.1W	5%	680Ω	
R712	ERJ6GEYJ472	S.M.CARB	0.1W	5%	4K7Ω	
R713	ERG1SJ101	METAL	1W	5%	100Ω	
R801	ERG3FJ682H	METAL	3W	5%	6K8Ω	▲
R802	ERG2FJ472	METAL	2W	5%	4K7Ω	▲
R803	ERX12SJWR47	METAL	12W	5%	R47	
R804	ERJ6GEYJ682	S.M.CARB	0.1W	5%	6K8Ω	
R805	ERJ6GEYJ221	S.M.CARB	0.1W	5%	220Ω	
R806	ERG1SJ823	METAL	1W	5%	820Ω	
R807	ERO25CKF1201	METAL	0.25W	1%	1K2Ω	▲
R808	232266296706	THERMISTOR				
R809	ERO25CKF1332	METAL	0.25W	1%	13KΩ	▲
R810	ERD25TJ103	CARBON	0.25W	5%	10KΩ	
R811	EVMEAS A00B33	CONTROL			3KΩ	
R812	ERDS1TJ220	CARBON	0.5W	5%	22Ω	
R813	ERD50FJ334	CARBON	0.5W	5%	330KΩ	▲
R814	ERF7ZK2R7	WOUND	7W	20%	2R7Ω	▲
R817	ERG3FJ470	METAL	3W	5%	47Ω	▲
R818	ERD50FJ564	CARBON	0.5W	5%	1KΩ	▲

Ref No.	Part No.	Description				
R819	ERD50FJ564	CARBON	0.5W	5%	1KΩ	▲
R820	ERD75TAJ825	CARBON	0.75W	5%	8M2Ω	▲
R852	ERJ6GEYJ271	S.M.CARB	0.1W	5%	270Ω	
R853	ERJ6GEYJ101	S.M.CARB	0.1W	5%	100Ω	
R854	ERDS1TJ474	CARBON	0.5W	5%	470KΩ	
R855	ERG2FJ223	METAL	2W	5%	22KΩ	▲
R856	ERJ6GEYJ102	S.M.CARB	0.1W	5%	1KΩ	
R901	ERJ6GEYJ562	S.M.CARB	0.1W	5%	5K6Ω	
R902	ERJ6GEYJ562	S.M.CARB	0.1W	5%	5K6Ω	
R903	ERJ6GEYJ562	S.M.CARB	0.1W	5%	5K6Ω	
R904	ERJ6GEYJ222	S.M.CARB	0.1W	5%	2K2Ω	
R905	ERJ6GEYJ681	S.M.CARB	0.1W	5%	680Ω	
R906	ERJ6GEYJ223	S.M.CARB	0.1W	5%	22KΩ	
R907	ERJ6GEYJ472	S.M.CARB	0.1W	5%	4K7Ω	
R908	ERJ6GEYJ471	S.M.CARB	0.1W	5%	470Ω	
R909	ERJ6GEYJ102	S.M.CARB	0.1W	5%	1KΩ	
R910	ERJ6GEYJ101	S.M.CARB	0.1W	5%	100Ω	
R911	ERJ6GEYJ152	S.M.CARB	0.1W	5%	1K5Ω	
R913	ERJ6GEYJ183	S.M.CARB	0.1W	5%	18KΩ	
R914	ERJ6GEYJ222	S.M.CARB	0.1W	5%	2K2Ω	
R915	ERJ6GEYJ182	S.M.CARB	0.1W	5%	1K8Ω	
R916	ERJ6GEYJ221	S.M.CARB	0.1W	5%	220Ω	
R917	ERJ6GEYJ121	S.M.CARB	0.1W	5%	120Ω	
R919	ERQ14AJ390	FUSIBLE	0.25W	5%	39Ω	▲
R920	ERQ14AJ390	FUSIBLE	0.25W	5%	39Ω	▲
R921	ERD25TJ471	CARBON	0.25W	5%	470Ω	
R922	ERD25TJ393	CARBON	0.25W	5%	39KΩ	
R923	ERD25TJ393	CARBON	0.25W	5%	39KΩ	
R924	ERDS1FJ390	CARBON	0.5W	5%	39Ω	▲
R927	ERD25TJ471	CARBON	0.25W	5%	470Ω	
R928	ERD25TJ5R6	CARBON	0.25W	5%	5R6Ω	
R929	ERDS1FJ471	CARBON	0.5W	5%	470Ω	▲
R930	ERD25TJ5R6	CARBON	0.25W	5%	5R6Ω	
R931	ERDS1FJ390	CARBON	0.5W	5%	39Ω	▲
R932	ERDS1FJ101	CARBON	0.5W	5%	100Ω	▲
R933	ERJ6GEYJ103	S.M.CARB	0.1W	5%	10KΩ	
R934	ERJ6GEYJ222	S.M.CARB	0.1W	5%	2K2Ω	
R935	ERQ14AJ3R9	FUSIBLE	0.25W	5%	3R9Ω	▲
R936	ERQ1CJP331	METAL	1W	5%	330Ω	▲
R937	ERQ14AJ100	METAL	0.25W	5%	10Ω	▲
R1201	ERJ6GEYJ271	S.M.CARB	0.1W	5%	270Ω	
R1202	ERJ6GEYJ101	S.M.CARB	0.1W	5%	100Ω	
R1203	ERJ6GEYJ101	S.M.CARB	0.1W	5%	100Ω	
R1204	ERJ6GEYJ101	S.M.CARB	0.1W	5%	100Ω	
R1205	ERJ6GEYJ101	S.M.CARB	0.1W	5%	100Ω	
R1206	ERJ6GEYJ101	S.M.CARB	0.1W	5%	100Ω	
R1207	ERD25TJ331	CARBON	0.25W	5%	330Ω	
R1208	ERJ6GEYJ223	S.M.CARB	0.1W	5%	22KΩ	
R1209	ERJ6GEYJ472	S.M.CARB	0.1W	5%	4K7Ω	
R1210	ERJ6GEYJ472	S.M.CARB	0.1W	5%	4K7Ω	
R1212	ERJ6GEYJ103	S.M.CARB	0.1W	5%	10KΩ	
R1213	ERJ6GEYJ103	S.M.CARB	0.1W	5%	10KΩ	
R1214	ERJ6GEYJ472	S.M.CARB	0.1W	5%	4K7Ω	
R1215	ERJ6GEYJ101	S.M.CARB	0.1W	5%	100Ω	
R1216	ERJ6GEYJ101	S.M.CARB	0.1W	5%	100Ω	
R1217	ERJ6GEYJ101	S.M.CARB	0.1W	5%	100Ω	
R1218	ERJ6GEYJ472	S.M.CARB	0.1W	5%	4K7Ω	
R1219	ERJ6GEYJ472	S.M.CARB	0.1W	5%	4K7Ω	
R1220	ERJ6GEYJ472	S.M.CARB	0.1W	5%	4K7Ω	
R1221	ERJ6GEYJ103	S.M.CARB	0.1W	5%	10KΩ	
R1222	ERJ6GEYJ103	S.M.CARB	0.1W	5%	10KΩ	
R1224	ERJ6GEYJ103	S.M.CARB	0.1W	5%	10KΩ	
R1225	ERJ6GEYJ472	S.M.CARB	0.1W	5%	4K7Ω	
R1226	ERJ6GEYJ472	S.M.CARB	0.1W	5%	4K7Ω	
R1227	ERJ6GEYJ472	S.M.CARB	0.1W	5%	4K7Ω	
R1229	ERJ6GEYOR00	S.M.CARB	0.1W	5%	0Ω	
R1230	ERJ6GEYOR00	S.M.CARB	0.1W	5%	0Ω	
R1231	ERJ6GEYJ472	S.M.CARB	0.1W	5%	4K7Ω	
R1232	ERJ6GEYJ103	S.M.CARB	0.1W	5%	10KΩ	
R1233	ERJ6GEYJ472	S.M.CARB	0.1W	5%	4K7Ω	
R1235	ERJ6GEYJ103	S.M.CARB	0.1W	5%	10KΩ	



Ref No.	Part No.	Description			
R1236	ERJ6GEYJ472	S.M.CARB	0.1W	5%	4K7Ω
R1237	ERJ6GEYJ103	S.M.CARB	0.1W	5%	10KΩ
R1238	ERJ6GEYJ393	S.M.CARB	0.1W	5%	39KΩ
R1239	ERJ6GEYJ392	S.M.CARB	0.1W	5%	3K9Ω
R1240	ERJ6GEYJ392	S.M.CARB	0.1W	5%	3K9Ω
R1241	ERJ6GEYJ101	S.M.CARB	0.1W	5%	100Ω
R1242	ERJ6GEYJ101	S.M.CARB	0.1W	5%	100Ω
R1244	ERJ6GEY0R00	S.M.CARB	0.1W	5%	0Ω
R1245	ERJ6GEYJ222	S.M.CARB	0.1W	5%	2K2Ω
R1246	ERJ6GEYJ103	S.M.CARB	0.1W	5%	10KΩ
R1247	ERJ6GEYJ103	S.M.CARB	0.1W	5%	10KΩ
R1249	ERJ6GEYJ472	S.M.CARB	0.1W	5%	4K7Ω
R1250	ERJ6GEYJ103	S.M.CARB	0.1W	5%	10KΩ
R1251	ERJ6GEYJ393	S.M.CARB	0.1W	5%	39KΩ
R1252	ERX1SJ3R3	METAL	1W	5%	3R3Ω
R1253	ERJ6GEYJ103	S.M.CARB	0.1W	5%	10KΩ
R1254	ERJ6GEYJ104	S.M.CARB	0.1W	5%	100KΩ
R1255	ERJ6GEYJ104	S.M.CARB	0.1W	5%	100KΩ
R1256	ERJ6GEYJ102	S.M.CARB	0.1W	5%	1KΩ
R1257	ERJ6GEYJ101	S.M.CARB	0.1W	5%	100Ω
R1258	ERJ6GEYJ472	S.M.CARB	0.1W	5%	4K7Ω
R1260	ERDS1FJ121	CARBON	0.5W	5%	120Ω
R2101	ERJ6GEYJ471	S.M.CARB	0.1W	5%	470Ω
R2102	ERJ6GEYJ222	S.M.CARB	0.1W	5%	2K2Ω
R2103	ERJ6GEYJ471	S.M.CARB	0.1W	5%	470Ω
R2104	ERJ6GEYJ471	S.M.CARB	0.1W	5%	470Ω
R2105	ERJ6GEYJ222	S.M.CARB	0.1W	5%	2K2Ω
R2106	ERJ6GEYJ183	S.M.CARB	0.1W	5%	18KΩ
R2107	ERJ6GEYJ471	S.M.CARB	0.1W	5%	470Ω
R2108	ERJ6GEYJ101	S.M.CARB	0.1W	5%	100Ω
R2109	ERJ6GEYJ101	S.M.CARB	0.1W	5%	100Ω
R2110	ERJ6GEYJ103	S.M.CARB	0.1W	5%	10KΩ
R2111	ERJ6GEYJ473	S.M.CARB	0.1W	5%	47KΩ
R2301	ERJ6GEYJ222	S.M.CARB	0.1W	5%	2K2Ω
R2302	ERJ6GEYJ222	S.M.CARB	0.1W	5%	2K2Ω
R2303	ERJ6GEYJ471	S.M.CARB	0.1W	5%	470Ω
R2304	ERJ6GEYJ471	S.M.CARB	0.1W	5%	470Ω
R2313	ERJ6GEYJ101	S.M.CARB	0.1W	5%	100Ω
R2314	ERJ6GEYJ101	S.M.CARB	0.1W	5%	100Ω
R2315	ERJ6GEYJ473	S.M.CARB	0.1W	5%	47KΩ
R2316	ERJ6GEYJ104	S.M.CARB	0.1W	5%	100KΩ
R2318	ERJ6GEYJ104	S.M.CARB	0.1W	5%	100KΩ
R2321	ERJ6GEYJ103	S.M.CARB	0.1W	5%	10KΩ
R2322	ERJ6GEYJ471	S.M.CARB	0.1W	5%	470Ω
R2323	ERJ6GEYJ103	S.M.CARB	0.1W	5%	10KΩ
R2324	ERJ6GEYJ471	S.M.CARB	0.1W	5%	470Ω
R2325	ERJ6GEYJ273	S.M.CARB	0.1W	5%	27KΩ
R2326	ERJ6GEYJ471	S.M.CARB	0.1W	5%	470Ω
R2327	ERJ6GEYJ471	S.M.CARB	0.1W	5%	470Ω
R2328	ERJ6GEYJ473	S.M.CARB	0.1W	5%	47KΩ
R2329	ERJ6GEYJ222	S.M.CARB	0.1W	5%	2K2Ω
R2330	ERJ6GEYJ222	S.M.CARB	0.1W	5%	2K2Ω
R2331	ERJ6GEYJ223	S.M.CARB	0.1W	5%	22KΩ
R2332	ERJ6GEYJ471	S.M.CARB	0.1W	5%	470Ω
R2333	ERJ6GEYJ471	S.M.CARB	0.1W	5%	470Ω
R2334	ERJ6GEY0R00	S.M.CARB	0.1W	5%	0Ω
R2335	ERJ6GEY0R00	S.M.CARB	0.1W	5%	0Ω
R2651	ERG2FJ221	METAL	2W	5%	220Ω
R2652	ERG2FJ221	METAL	2W	5%	220Ω
R2653	ERDS1TJ151	CARBON	0.5W	5%	150Ω
R2654	ERDS1TJ151	CARBON	0.5W	5%	150Ω
R3001	ERJ6GEYJ153	S.M.CARB	0.1W	5%	15KΩ
R3002	ERJ6GEYJ101	S.M.CARB	0.1W	5%	100Ω
R3003	ERJ6GEYJ101	S.M.CARB	0.1W	5%	100Ω
R3004	ERJ6GEYJ153	S.M.CARB	0.1W	5%	15KΩ
R3005	ERJ6GEYJ470	S.M.CARB	0.1W	5%	47Ω
R3006	ERJ6GEYJ470	S.M.CARB	0.1W	5%	47Ω
R3007	ERJ6GEYJ750	S.M.CARB	0.1W	5%	75Ω
R3008	ERJ6GEYJ104	S.M.CARB	0.1W	5%	100KΩ
R3009	ERJ6GEYJ104	S.M.CARB	0.1W	5%	100KΩ
R3010	ERJ6GEYJ101	S.M.CARB	0.1W	5%	100Ω
R3011	ERJ6GEYJ101	S.M.CARB	0.1W	5%	100Ω

Ref No.	Part No.	Description			
R3012	ERJ6GEYJ101	S.M.CARB	0.1W	5%	100Ω
R3013	ERJ6GEYJ101	S.M.CARB	0.1W	5%	100Ω
R3015	ERJ6GEY0R00	S.M.CARB	0.1W	5%	0Ω
R3016	ERJ6GEYJ103	S.M.CARB	0.1W	5%	10KΩ
R3017	ERJ6GEYJ102	S.M.CARB	0.1W	5%	1KΩ
R3019	ERJ6GEYJ471	S.M.CARB	0.1W	5%	470Ω
R3020	ERJ6GEYJ103	S.M.CARB	0.1W	5%	10KΩ
R3022	ERD2FCG560	CARBON	2W	2%	56Ω
R3024	ERJ6GEYJ471	S.M.CARB	0.1W	5%	470Ω
R3025	ERJ6GEYJ103	S.M.CARB	0.1W	5%	10KΩ
R3026	ERJ6GEYJ471	S.M.CARB	0.1W	5%	470Ω
R3027	ERJ6GEYJ680	S.M.CARB	0.1W	5%	68Ω
R3029	ERJ6GEYJ680	S.M.CARB	0.1W	5%	68Ω
R3030	ERJ6GEYJ103	S.M.CARB	0.1W	5%	10KΩ
R3032	ERJ6GEYJ680	S.M.CARB	0.1W	5%	68Ω
R3034	ERJ6GEYJ103	S.M.CARB	0.1W	5%	10KΩ
R3036	ERJ6GEYJ220	S.M.CARB	0.1W	5%	22Ω
R3037	ERJ6GEYJ750	S.M.CARB	0.1W	5%	75Ω
R3038	ERD2FCG100	CARB	2W	2%	10Ω
R3039	ERJ6GEYJ101	S.M.CARB	0.1W	5%	100Ω
R3040	ERJ6GEYJ101	S.M.CARB	0.1W	5%	100Ω
R3041	ERJ6GEYJ153	S.M.CARB	0.1W	5%	15KΩ
R3042	ERJ6GEYJ472	S.M.CARB	0.1W	5%	4K7Ω
R3043	ERD2FCG100	CARB	2W	2%	10Ω
R3044	ERJ6GEYJ101	S.M.CARB	0.1W	5%	100Ω
R3045	ERJ6GEYJ471	S.M.CARB	0.1W	5%	470Ω
R3046	ERJ6GEYJ101	S.M.CARB	0.1W	5%	100Ω
R3047	ERJ6GEYJ680	S.M.CARB	0.1W	5%	68Ω
R3048	ERJ6GEYJ102	S.M.CARB	0.1W	5%	1KΩ
R3049	ERJ6GEYJ750	S.M.CARB	0.1W	5%	75Ω
R3050	ERJ6GEYJ101	S.M.CARB	0.1W	5%	100Ω
R3051	ERJ6GEYJ101	S.M.CARB	0.1W	5%	100Ω
R3052	ERJ6GEYJ101	S.M.CARB	0.1W	5%	100Ω
R3053	ERJ6GEYJ101	S.M.CARB	0.1W	5%	100Ω
R3054	ERJ6GEYJ101	S.M.CARB	0.1W	5%	100Ω
R3055	ERJ6GEYJ101	S.M.CARB	0.1W	5%	100Ω
R3056	ERJ6GEYJ101	S.M.CARB	0.1W	5%	100Ω
R3057	ERJ6GEYJ101	S.M.CARB	0.1W	5%	100Ω
R3058	ERJ6GEYJ153	S.M.CARB	0.1W	5%	15KΩ
R3059	ERJ6GEYJ153	S.M.CARB	0.1W	5%	15KΩ
R3060	ERJ6GEYJ470	S.M.CARB	0.1W	5%	47Ω
R3062	ERJ6GEYJ750	S.M.CARB	0.1W	5%	75Ω
R3063	ERJ6GEYJ750	S.M.CARB	0.1W	5%	75Ω
R3064	ERJ6GEYJ103	S.M.CARB	0.1W	5%	10KΩ
R3065	ERJ6GEYJ104	S.M.CARB	0.1W	5%	100KΩ
R3066	ERJ6GEYJ104	S.M.CARB	0.1W	5%	100KΩ
R3067	ERJ6GEYJ273	S.M.CARB	0.1W	5%	27KΩ
R3068	ERJ6GEYJ103	S.M.CARB	0.1W	5%	10KΩ
R3069	ERJ6GEYJ103	S.M.CARB	0.1W	5%	10KΩ
R3070	ERJ6GEYJ750	S.M.CARB	0.1W	5%	75Ω
R3071	ERJ6GEYJ470	S.M.CARB	0.1W	5%	47Ω
R3150	ERJ6GEYJ750	S.M.CARB	0.1W	5%	75Ω
R3151	ERJ6GEYJ750	S.M.CARB	0.1W	5%	75Ω
R3152	ERJ6GEYJ750	S.M.CARB	0.1W	5%	75Ω
R3153	ERJ6GEYJ750	S.M.CARB	0.1W	5%	75Ω
R3154	ERJ6GEYJ153	S.M.CARB	0.1W	5%	15KΩ
R3155	ERJ6GEYJ101	S.M.CARB	0.1W	5%	100Ω
R3156	ERJ6GEYJ101	S.M.CARB	0.1W	5%	100Ω
R3157	ERJ6GEYJ153	S.M.CARB	0.1W	5%	15KΩ
R3158	ERJ6GEYJ750	S.M.CARB	0.1W	5%	75Ω
R3502	ERJ6GEYJ101	S.M.CARB	0.1W	5%	100Ω
R3504	ERJ6GEYJ101	S.M.CARB	0.1W	5%	100Ω
R3505	ERJ6GEY0R00	S.M.CARB	0.1W	5%	0Ω
R3508	ERJ6GEYJ183	S.M.CARB	0.1W	5%	18KΩ
R3511	ERJ6GEYJ103	S.M.CARB	0.1W	5%	10KΩ
R3512	ERJ6GEYJ472	S.M.CARB	0.1W	5%	4K7Ω

**SWITCHES**

S.351	0330550049	CRT SOCKET
S801	ESB91232A	SWITCH



Ref No.	Part No.	Description
S1201	EVQ23405R	SWITCH
S1202	EVQ23405R	SWITCH
S1203	EVQ23405R	SWITCH
S1204	EVQ23405R	SWITCH
S1205	EVQ23405R	SWITCH
<b>TRANSFORMERS</b>		
T501	5270103200	TRANSFORMER
T551	ZTFH65008A	TRANSFORMER
T801	TLP8E1002	TRANSFORMER
T1201	ETP35KAN61ZU	TRANSFORMER

Ref No.	Part No.	Description
<b>FILTERS</b>		
X101	EFC55M7MW3	CERAMIC FILTER
X103	G3355K	SAW FILTER
X105	EFCV3095A6	CHIP FILTER
X601	TSS2169-B	CRYSTAL
X1201	TSS120M2	CRYSTAL
X2101	TSS4004-B	CRYSTAL







## SCHEMATIC DIAGRAM FOR MODELS

### TX-28LD7C (Euro-2L Chassis)

#### IMPORTANT SAFETY NOTICE

Components identified by  mark have special characteristics important for safety. When replacing any of these components, use only manufacturer's specified parts.

#### Notes

- RESISTOR**  
All resistors are carbon 1/4W resistor, unless marked as follows:  
Unit of resistance is OHM ( $\Omega$ ) (K=1,000, M=1,000,000).
- CAPACITORS**  
All capacitors are ceramic 50V, unless marked as follows:  
Unit of capacitance is  $\mu$ F, unless otherwise stated.
- COIL**  
Unit of inductance is  $\mu$ H, unless otherwise stated.
- Components marked 'L' on the schematic diagram shows leadless parts.
- TEST POINT**  
 : Test Point position
- EARTH SYMBOL**  
 : Chassis Earth (Cold)  : Line Earth (Hot)
- VOLTAGE MEASUREMENT**  
Voltage is measured by a DC voltmeter.  
Measurement conditions are as follows:  
Power source AC 220V-240V, 50Hz  
Receiving Signal Colour Bar signal (RF)  
All customer controls Maximum position
-  : Indicates the Video signal path  
 : Indicates the Audio signal path  
 : Indicates the Vertical/Horizontal signal path
- This schematic diagram is the latest at the time of printing and is subject to change without notice.

#### Remarks

- The Power Circuit contains a circuit area which uses a separate power supply to isolate the earth connection. The circuit is defined by HOT and COLD indications in the schematic diagram. All circuits, except the Power Circuit, are COLD. Take the following precautions:

#### Precautions

- Do not touch the hot part, or the hot and cold parts at the same time, as you are liable to a shock hazard.
- Do not short-circuit the hot and cold circuits as electrical components may be damaged.
- Do not connect an instrument, such as an oscilloscope, to the hot and cold circuits simultaneously, as this may cause fuse failure. Connect the earth of the instruments to the earth connection of the circuit being measured.
- Make sure to disconnect the power plug before removing the chassis.







## ZEICHENERKLÄRUNG FÜR MODELL

### TX-28LD7C (Euro-2L Chassis)

#### WICHTIGER SICHERHEITSHINWEIS

Teile, die mit einem Hinweis  gekennzeichnet sind, sind wichtig für die Sicherheit. Sollte ein Auswechseln erforderlich sein, sind unbedingt Originalteile einzusetzen.

#### Anmerkung

- WIDERSTÄNDE**  
Alle 1/4Watt Widerstände sind Kohlewiderstände, Abweichungen sind folgt gekennzeichnet.  
Die Maßeinheit ist OHM ( $\Omega$ ) (K=1,000 M=1,000,000)
- KONDENSATOREN**  
Alle Kondensatoren sind Keramikausführungen  
Spannungsfestigkeit 50V. Abweichungen sind wie folgt gekennzeichnet.  
Die Maßeinheit ist  $\mu$ F, wenn keine anderen Bezeichnungen genannt sind
- SPULEN**  
Die Maßeinheit ist  $\mu$ H, Abweichungen sind gekennzeichnet.  
Mit 'L' gekennzeichnete Teile sind ohne Anschlußdrähte.
- TESTPUNKE**  
 : Kennzeichnung der Testpunktpositio
- MASSE SYMBOL**  
 : Erdung am Chassis  : Erdung an Masse-Leitung 
- SPANNUNGSMESSUNG**  
Spannungsmessungen sind mit einem DC-Voltmeter durchzuführen. Die Meßbedingungen sind folgende:  
Netzspannung AC 220V-240V 50Hz  
Wiedregabe Signal Farbbalken-Testbild  
Alle übrigen Einstellungen für Benutzer Sollangaben
-  : Videosignalweg  
 : Audiosignalweg  
 : Signalweg für Hor/Vert. Synchronsignale
- Anderungen im Laufe der Fertigung sind möglich.

#### Bemerkungen

- Das Schaltnetzteil enthält Bereiche, die direkt mit dem Netz verbunden sind. Diese Bereiche sind im Schalplan mit HOT gekennzeichnet. Alle anderen Schaltungen sind mit COLD gekennzeichnet und haben keine direkte Verbindung mit dem Netz.

#### Für den netzverbundenen Bereich (HOT) sind folgende Vorsichtsmassregeln zu beachten:

- Weder die Leitungen im heißen noch Leitungen im kalten Bereich gleichzeitig berühren. Es besteht die Gefahr eines elektrischen Schlages.
- Keinesfalls die Leitungen im heißen Bereich mit denen im kalten Bereich verbinden oder kurzschliessen. Dies kann zur Zerstörung von Bauteilen oder Sicherungen führen. Außerdem ist die elektrische Betriebssicherheit des Gerätes nicht mehr gegeben.
- Keine Messinstrumente gleichzeitig an Leitungen im heißen und kalten Bereich anschliessen. Sicherungen könnten zerstört werden. Die Erde des Messinstrumentes immer mit der des zu prüfenden Schaltkreises verbinden.
- Vor Ausbau des Chassis, Stecker aus der Netzsteckdose ziehen.

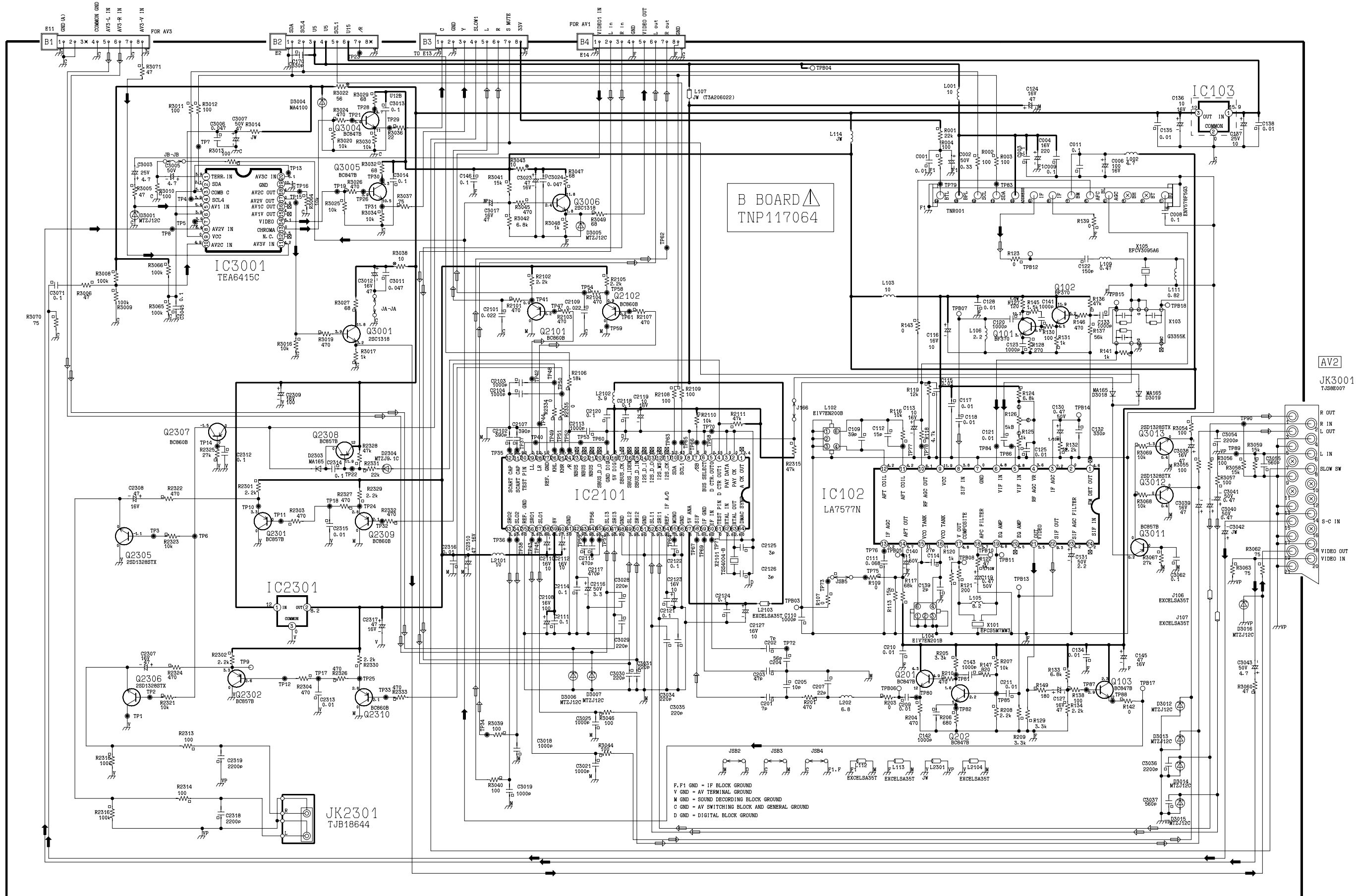

B BOARD  
TNP117064

AV2  
JK3001  
TJ38E007

JK2301  
TJB18644

F, F1 GND = IF BLOCK GROUND  
V GND = AV TERMINAL GROUND  
M GND = SOUND RECORDING BLOCK GROUND  
C GND = AV SWITCHING BLOCK AND GENERAL GROUND  
D GND = DIGITAL BLOCK GROUND

JK3102  
TJB16673

AV3

JK3101  
TJ38E007

AV1

E BOARD  
TNP197091

AC CORD  
TSXB0017 (UK)

\* VOLTAGES MAY VARY

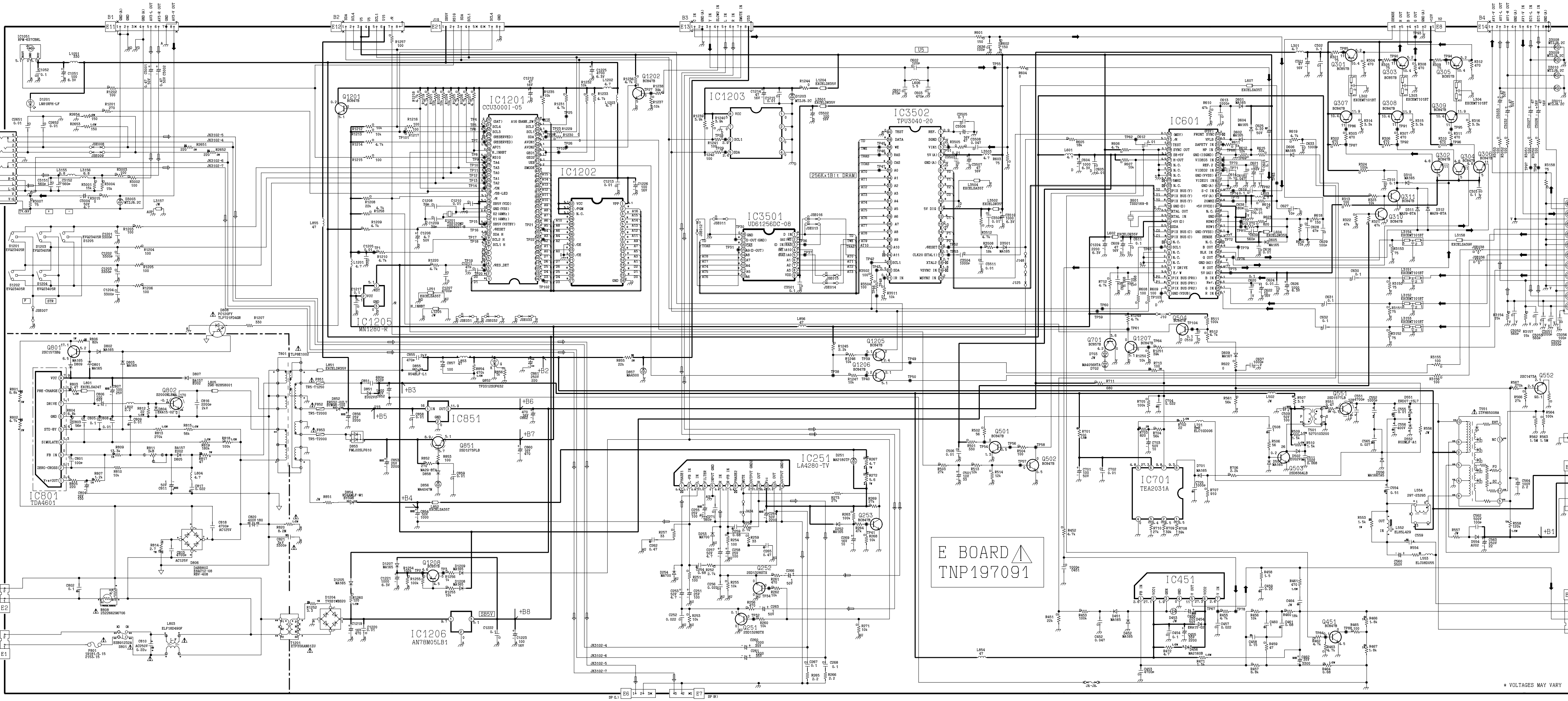



TP117064

R0071

SEE REVERSE FOR ORDER NO.

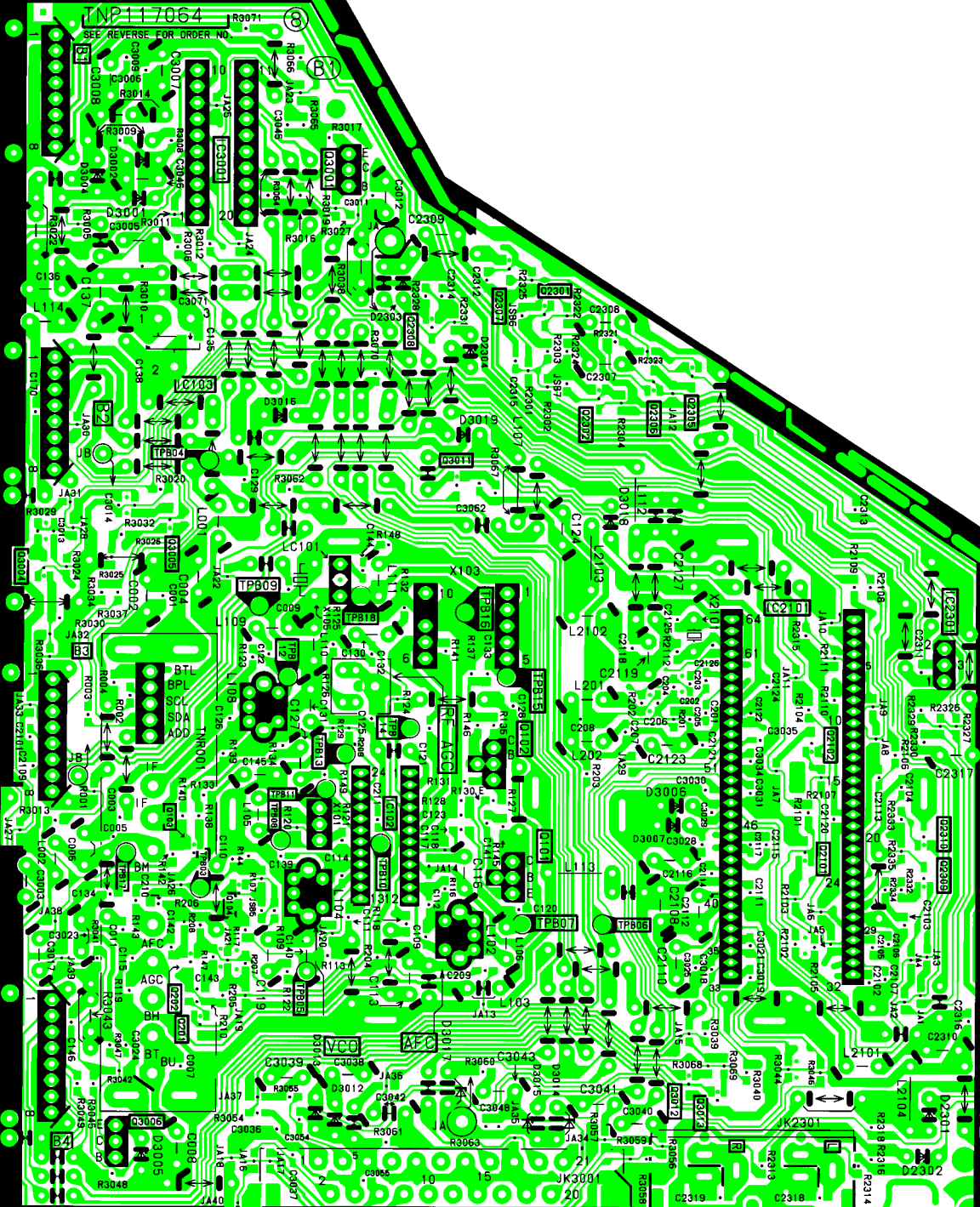





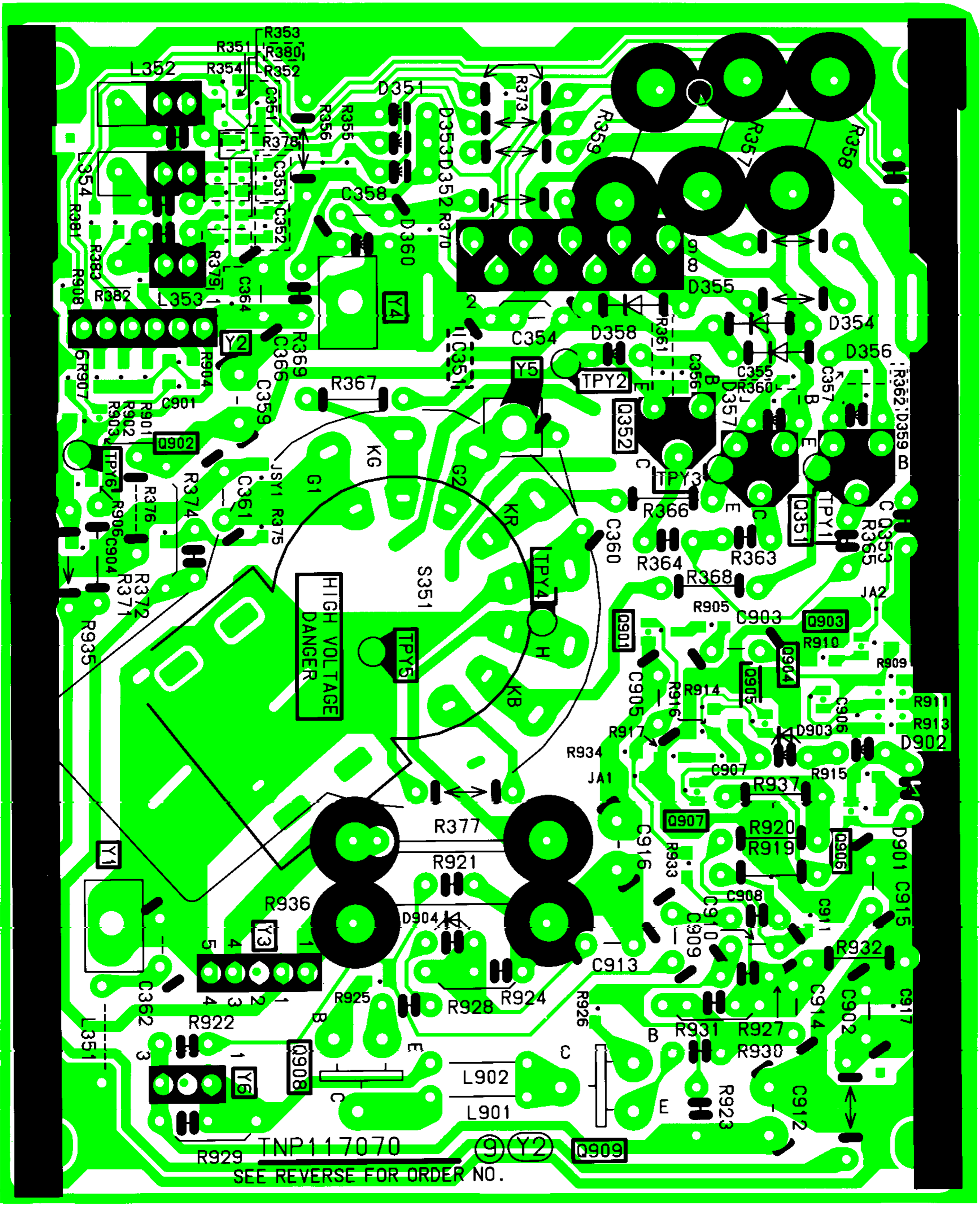

**HIGH VOLTAGE  
DANGER**

R929 TNP117070

SEE REVERSE FOR ORDER NO.

9 Y2

Q909